

Blaenau Gwent County Borough
Council

**Silent Valley Landfill, Waste
Transfer Station**

Site condition report

2015/9363

Issue 1 | 17 April 2015

This report takes into account the particular instructions and requirements of our client.

It is not intended for and should not be relied upon by any third party and no responsibility is undertaken to any third party.

Job number 115825-00

Ove Arup & Partners Ltd
4 Pierhead Street
Capital Waterside
Cardiff CF10 4QP
United Kingdom
www.arup.com

ARUP

Document Verification

ARUP

Job title		Silent Valley Landfill, Waste Transfer Station		Job number	
				115825-00	
Document title		Site condition report		File reference	
				4-50	
Document ref		2015/9363			
Revision	Date	Filename	001 Site condition report.docx		
Issue 1	17 Apr 2015	Description	Issue		
			Prepared by	Checked by	Approved by
		Name	Flavia Cappelletti	Charlie Martin	Charlie Martin
		Signature			
		Filename			
		Description			
			Prepared by	Checked by	Approved by
		Name			
		Signature			
		Filename			
		Description			
			Prepared by	Checked by	Approved by
		Name			
		Signature			

Issue Document Verification with Document



Contents

	Page
1.0 Site details	2
2.0 Condition of the land at permit issue	3
3.0 Permitted activities	8

Appendices

Appendix A

Figures

Appendix B

Note on ground investigation results, April 2015

Introduction

This document presents the Site Condition Report (SCR) for the proposed waste transfer station extension located to the north-west of Silent Valley landfill, Cwm, Ebbw Vale. The site is owned by Blaenau Gwent County Borough Council (BGCBC) and operated by Silent Valley Waste Services Ltd.

A SCR is required to be submitted to Natural Resources Wales (NRW) as part of the application for a permit variation to operate the waste transfer station extension under the Environment Agency Environmental Permitting (England and Wales) Regulations 2010.

The objective of this SCR is to describe and record the current condition of the land and groundwater at the site and, in particular, to identify any substance in, on or under the land that may constitute a pollution risk. Records of the site and surrounding areas have therefore been reviewed and an environmental risk assessment has been undertaken as part of the SCR.

The SCR will need to be updated throughout the lifetime of the facility to allow the operator to demonstrate that land and groundwater have been protected during this time. At the point of permit surrender, a Surrender SCR will be produced to describe the condition of the land and groundwater and demonstrate that the site is in a satisfactory state so that the Environment Agency can allow the permit to be surrendered.

The report format and contents are set out in accordance with the Environment Agency H5 SCR Guidance for Applicants v3.0 (May 2013). In accordance with the guidance, Sections 1 to 3 have been completed for the permit application stage. Section 4 to 7 are required to be maintained by BGCBC during the lifetime of operation of the installation and Sections 8 to 10 are required to be completed as part of the permit surrender application.

The sections of the report, as detailed in the EA H5 SCR guidance, are set out below:

Permit application stage (current stage)	Section 1.0	Site details
	Section 2.0	Condition of the land at permit issue
	Section 3.0	Permitted activities
Operational phase	Section 4.0	Changes to the activity
	Section 5.0	Measures taken to protect land
	Section 6.0	Pollution incidents that may have had an impact on land and their remediation
	Section 7.0	Soil gas and water quality monitoring
Permit surrender application stage	Section 8.0	Decommissioning and removal of pollution risk
	Section 9.0	Reference data and remediation
	Section 10.0	Statement of site condition

1.0 Site details

The installation construction is currently under way.

Name of the applicant	Blaenau Gwent County Borough Council
Activity address	Beechwood House, Cwm, Ebbw Vale, NP23 6PZ
National grid reference	318330, 207210 (approximate coordinates)

Document reference and dates for Site Condition Report at permit application and surrender	Site Condition Report, Application for variation of permit SEW/224 Document reference 2015/9363 April 2015
---	--

Document references for site plans (including location and boundaries)	<p>Figure 1 – Site location plan</p> <p>Figure 2 – Site layout plan</p> <p>General arrangement plan (BGCBC drawing)</p> <p>Proposed drainage layout (BGCBC drawing)</p> <p>The documents above are presented in Appendix A.</p> <p>Drawing ESID13-1, Landfill PPC application, Source, pathway and receptors (Silent Valley Waste Service Ltd.), see Ref. [15].</p>
---	---

<ul style="list-style-type: none"> • surface waters 	<p>or reducing the downward circulation of groundwater, which, in combination with the valley topography, will be predominantly along the dip of the beds within the sandstone strata over the mudstone/siltstone strata. Groundwater is therefore directed to the weathered bedrock horizon and moves down-gradient in this horizon being prevented from movement to greater depth by mudstone/siltstone strata and the dip of these strata. Frequent well-developed spring lines have been noticed at sandstone/mudstone boundaries in the valley, which strengthen the validity of such theory. Consequently, groundwater flow in the area will be largely restricted to the near surface strata within the weathered siltstone/sandstone/mudstone horizon and will flow downhill along the weathered rockhead topography and along the dip of the beds. This is confirmed by observations in groundwater wells that indicate a shallow water table in the weathered bedrock horizon.</p> <p>The Environment Agency’s website (Ref. [8]) shows the bedrock to be classified as Secondary A aquifer, defined as permeable rock layers capable of supporting water supplies at a local rather than strategic scale and can form an important source of base flow to rivers.</p> <p>A surface water ditch is present to the immediate north of the site to collect water run-off from the slag heaps located to the north of the site (see below for additional details on slag heaps). This is then discharged to the Nant Merddog downstream.</p> <p>Ditches are also present along the western and eastern perimeters of the capped landfill area located to the south of the site to collect surface water run-off from the sloping sides of the capping.</p> <p>The Nant Merddog has been culverted and diverted to the east of the site and the landfill, approximately 150m from the site.</p>
<p>Pollution history including:</p> <ul style="list-style-type: none"> • pollution incidents that may have affected land • historical land-uses and associated contaminants 	<p>The Environment Agency website (Ref. [8]) shows no pollution incidents recorded to have taken place within the site or its vicinity.</p> <p>The site is adjacent to an existing waste transfer station and is located to the north of the Silent Valley landfill. A large number of contaminants may be associated with waste management facilities, including waste transfer stations; however the extent of contamination at a waste transfer station site is generally dependent for the most part on the methods used for controlling surface water run-off and whether or not the operations are undertaken on hard-standing (Ref. [10]). The existing waste transfer station is located on concrete slabs and storm pipes to collect water run-off draining from the slabs.</p> <p>British Steel Corporation historically owned the site and trenches were dug to the immediate north of the proposed development to dispose of steel works waste and associated waste lubricant oils, including waste palm oil. Slag heaps are also present to the north of the site associated with the historical steelworks.</p>

<ul style="list-style-type: none"> any visual/olfactory evidence of existing contamination 	<p>Contaminants associated with steelworks include metals, organic compounds (such as cyanide and sulphates), inorganic compounds (including hydrocarbons, phenols and PCBs) and asbestos (Ref. [11]).</p> <p>The recent ground investigation recorded made ground to be present to a depth in excess of 2.7m generally across the site (Ref. [7]). A number of geo-environmental soil samples taken during the GI displayed visual and/or olfactory evidence of hydrocarbon contamination, as detailed in Ref. [7] and summarised in the table below.</p> <table border="1" data-bbox="694 571 1401 1350"> <thead> <tr> <th>Trial pit location</th> <th>Depth of sample</th> <th>Evidence of contamination</th> </tr> </thead> <tbody> <tr> <td rowspan="2">TP01</td> <td>0.6m</td> <td>Presence of slag in black soil matrix.</td> </tr> <tr> <td>1.2m</td> <td>Presence of slag in black soil matrix.</td> </tr> <tr> <td rowspan="5">TP2</td> <td>0.25m</td> <td rowspan="3">Presence of slag, bricks and fragments of metal, timber, plastic and tin. (stratum as above)</td> </tr> <tr> <td>1.0m</td> </tr> <tr> <td>1.7m</td> </tr> <tr> <td>2.5m</td> <td>Presence of slag, bricks, timber, metal, wires in black soil matrix. Strong hydrocarbon odour.</td> </tr> <tr> <td>2.7m</td> <td>Presence of slag. Strong hydrocarbon odour.</td> </tr> <tr> <td rowspan="4">TP3</td> <td>0.3m</td> <td rowspan="2">Presence of slag, bricks, plastic, timber, tiles, clothes, construction rubble.</td> </tr> <tr> <td>0.8m</td> </tr> <tr> <td>1.9m</td> <td>Presence of slag and bricks. Strong hydrocarbon odour.</td> </tr> <tr> <td>2.4m</td> <td>Presence of slag, bricks, construction rubble, plastic in black soil matrix. (stratum as above)</td> </tr> <tr> <td rowspan="2">TP4</td> <td>0.6m</td> <td>Presence of slag, bricks, construction rubble, plastic and metal. Hydrocarbon odour</td> </tr> <tr> <td>1.2m</td> <td>Presence of slag. Hydrocarbon odour.</td> </tr> </tbody> </table>	Trial pit location	Depth of sample	Evidence of contamination	TP01	0.6m	Presence of slag in black soil matrix.	1.2m	Presence of slag in black soil matrix.	TP2	0.25m	Presence of slag, bricks and fragments of metal, timber, plastic and tin. (stratum as above)	1.0m	1.7m	2.5m	Presence of slag, bricks, timber, metal, wires in black soil matrix. Strong hydrocarbon odour.	2.7m	Presence of slag. Strong hydrocarbon odour.	TP3	0.3m	Presence of slag, bricks, plastic, timber, tiles, clothes, construction rubble.	0.8m	1.9m	Presence of slag and bricks. Strong hydrocarbon odour.	2.4m	Presence of slag, bricks, construction rubble, plastic in black soil matrix. (stratum as above)	TP4	0.6m	Presence of slag, bricks, construction rubble, plastic and metal. Hydrocarbon odour	1.2m	Presence of slag. Hydrocarbon odour.
Trial pit location	Depth of sample	Evidence of contamination																													
TP01	0.6m	Presence of slag in black soil matrix.																													
	1.2m	Presence of slag in black soil matrix.																													
TP2	0.25m	Presence of slag, bricks and fragments of metal, timber, plastic and tin. (stratum as above)																													
	1.0m																														
	1.7m																														
	2.5m	Presence of slag, bricks, timber, metal, wires in black soil matrix. Strong hydrocarbon odour.																													
	2.7m	Presence of slag. Strong hydrocarbon odour.																													
TP3	0.3m	Presence of slag, bricks, plastic, timber, tiles, clothes, construction rubble.																													
	0.8m																														
	1.9m	Presence of slag and bricks. Strong hydrocarbon odour.																													
	2.4m	Presence of slag, bricks, construction rubble, plastic in black soil matrix. (stratum as above)																													
TP4	0.6m	Presence of slag, bricks, construction rubble, plastic and metal. Hydrocarbon odour																													
	1.2m	Presence of slag. Hydrocarbon odour.																													
<ul style="list-style-type: none"> evidence of damage to pollution prevention measures 	<p>There is no evidence of damage to pollution prevention measures to the existing waste transfer station.</p> <p>The proposed extension development is not yet constructed and detailed design is yet to be confirmed.</p>																														
<p>Evidence of historic contamination, for example, historical site investigation, assessment, remediation and verification reports (where available)</p>	<p>Contamination relating to construction and demolition materials and likely to be associated with the historical steelworks and steelworks waste present to the immediate north of the site has been identified during the recent ground investigation undertaken at the site (Ref. [7]) The GI identified relatively elevated levels of hydrocarbons (PAHs and TPHs) in relation to risks to site operatives and asbestos fibres. Consequently, suitable PPE and working practices will be required during the construction works. With regard to site end users, the site is considered acceptable for the proposed use. For details, see Ref. [7], included in Appendix B.</p> <p>Groundwater quality monitoring is undertaken monthly in GM11a located within the site (see Figure 2 for location). Recent chemical analyses results identified relatively elevated concentrations of manganese and sulphate, likely to</p>																														

	<p>be originating from the steelworks waste to the north of the site. For further details, see Ref. [9].</p> <p>Gas quality monitoring is carried out monthly in GMW1 and GMW10 in the locale of the site (see Figure 2), which generally show relatively elevated carbon dioxide and methane concentrations typical of wells in close proximity to landfill waste mass. No mitigation action is considered necessary in relation to the proposed development.</p> <p>A sample of gas was obtained from the valve located at 14.7m depth in GMW1 and sent for laboratory testing In September 2014. The measured concentrations of methane and carbon dioxide in the laboratory were in line with the monitored concentrations at this location during 2014. In addition, carbon monoxide, organic silicon and total sulphur were detected, with trace components of toluene, methylcyclosiloxanes, hydrogen sulphides, xylene, alpha-pinene and paracymene, all typically found in landfill gas.</p>
Baseline soil and groundwater reference data	<p>Baseline ground condition data, including ground investigation information and recent soil analyses results specific to the site, as described in the sections above, is presented in Ref. [5] to [8]. The suite of chemical analysis for soil scoped for the recent GI (Ref. [7]) included metals, speciated polycyclic aromatic hydrocarbons (PAHs), speciated total petroleum hydrocarbons, cyanide, phenol, acid-soluble sulphates, sulphides, pH and asbestos (screening and quantification analysis).</p> <p>Groundwater and gas quality monitoring has been carried out in GM11a, GMW1 and GMW10 in the vicinity of the site (see Figure 2 for locations) in accordance with the Silent Valley Environmental Permit (Permit no. MP3835SV, Ref. [13]).</p>
Supporting information	<p>The information provided in this section of the SCR is based on the following documents:</p> <ul style="list-style-type: none"> [1] British Geological Survey (BGS) 1:50,000 Sheet 232, Abergavenny; [2] British Geological Survey (BGS) 1:10,000 scale geological map SO 10 NE; [3] Memoir of the Geological Survey, South Wales Coalfield - Part 2 - Abergavenny; [4] Ove Arup and Partners Ltd, Hydrogeological Risk Assessment; [5] Silent Valley Waste Services Limited, Historical records of boreholes, trial pits and trial trenches at Silent Valley landfill Site – Version 1, April 2005 [6] Ove Arup and Partners Ltd, Trial pit logs for the northern cut-off, November 2012 [7] Ove Arup and Partners Ltd, File Note, Silent Valley Landfill, Silent Valley Waste Transfer Station – Ground investigation results, 14th April 2015 [8] Environment agency’s website, What’s in your backgarden? (accessed on 13/04/15), http://maps.environment-agency.gov.uk [9] Arup, Silent Valley Landfill, 2014 Annual Monitoring Report, document reference 2015/9326, February 2015

	<p>Other documents referred to in this SCR include:</p> <ul style="list-style-type: none">[10] Department of the Environment, Industry Profile, Waste recycling, treatment and disposal sites, Landfills and other waste treatment or waste disposal sites[11] Department of the Environment, Industry Profile, Metal manufacturing, refining and finishing works, Iron and steel works[12] Working plan, version 5 March 2013, Silent Valley waste transfer station and treatment plant (Permit nr. SEW/224)[13] Waste Management Licence, No. SEW/224[14] Environment Agency, Silent Valley Landfill Site, Pollution Prevention and Control (England and Wales) Regulations 2000, Landfill (England and Wales) Regulations 2002, Permit number MP3835SV, November 2005.[15] Silent Valley Waste Services limited, PART B of Application Form for the Landfill Sector, Drawings referred to by Section A, Conceptual Model, Environmental Setting and Design report, Version 1 – November 2004
--	--

3.0 Permitted activities

Permitted activities	<p>The following permitted activities will be undertaken at the site:</p> <ul style="list-style-type: none"> • D15: Storage pending any of the operations numbered D1 to D14 (excluding temporary storage, pending collection, on the site where it is produced) • R13: Storage of wastes pending any of the operations numbered R1 to R12 (excluding temporary storage, pending collection, on the site where it is produced) • D14: Repackaging prior to submission to any of the operations numbered D1 to 13 • D9: Physico-chemical treatment not specified elsewhere in Annex IIA which results in final compounds or mixtures which are discarded by means of any of the operations numbered D1 to D8 and D10 to D12 • R3: Recycling/reclamation of organic substances which are not used as solvents • R4: Recycling/reclamation of metals and metal compounds • R5: Recycling/reclamation of other inorganic materials
Non-permitted activities undertaken	<ul style="list-style-type: none"> • the extension will undertake treatment in the form of sorting and baling and will also facilitate short to medium term storage of materials; • it is proposed to receive and store asbestos on site prior movement to a suitable disposal facility.
<p>Document references for:</p> <ul style="list-style-type: none"> • plan showing activity layout; and • environmental risk assessment. 	To be completed.

Appendix A

Figures

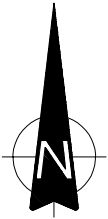

DEVELOPMENT
SITE

SILENT VALLEY
LANDFILL

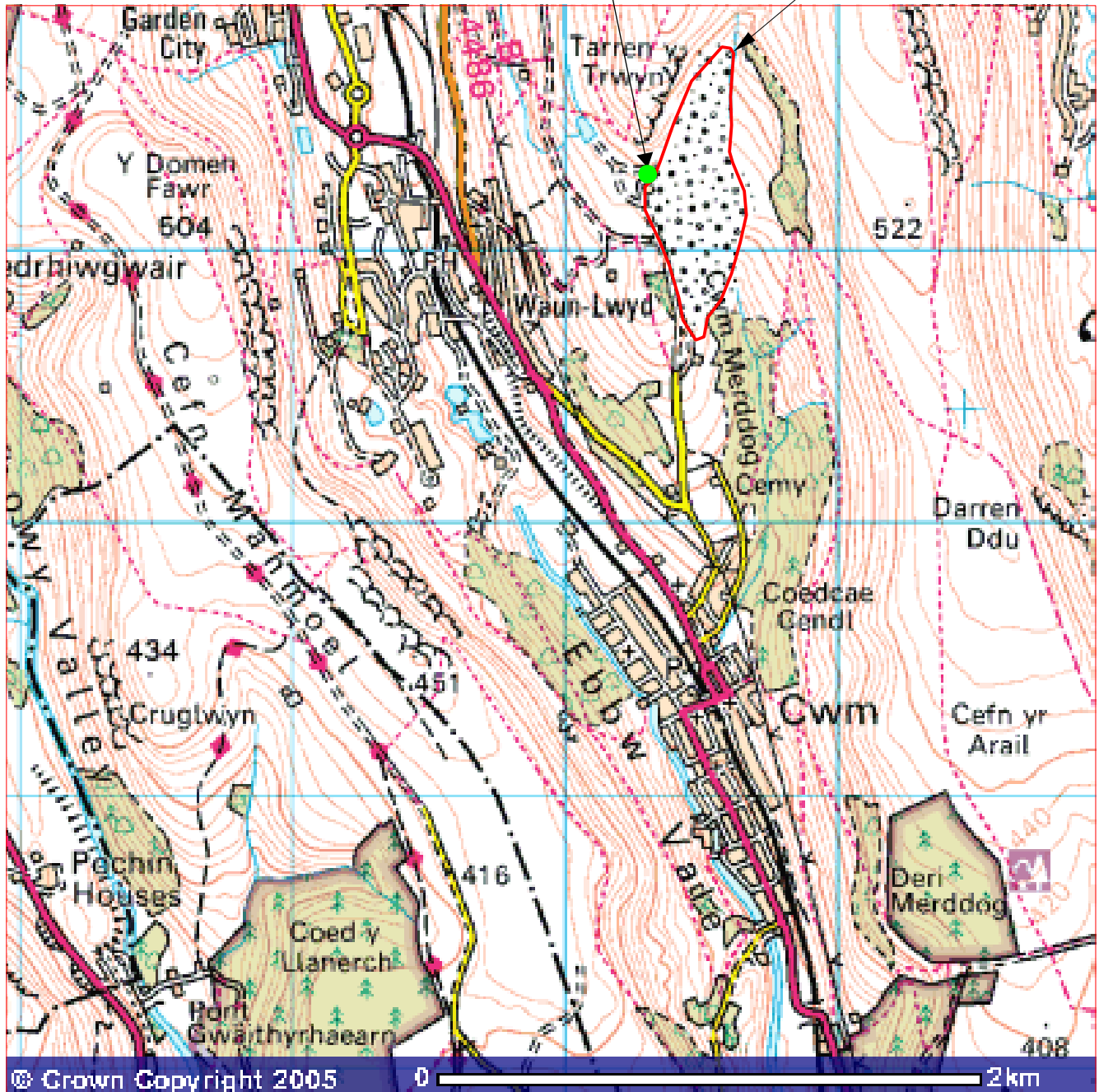

Silent Valley
SITE LOCATION PLAN
115825-00
FIGURE 1

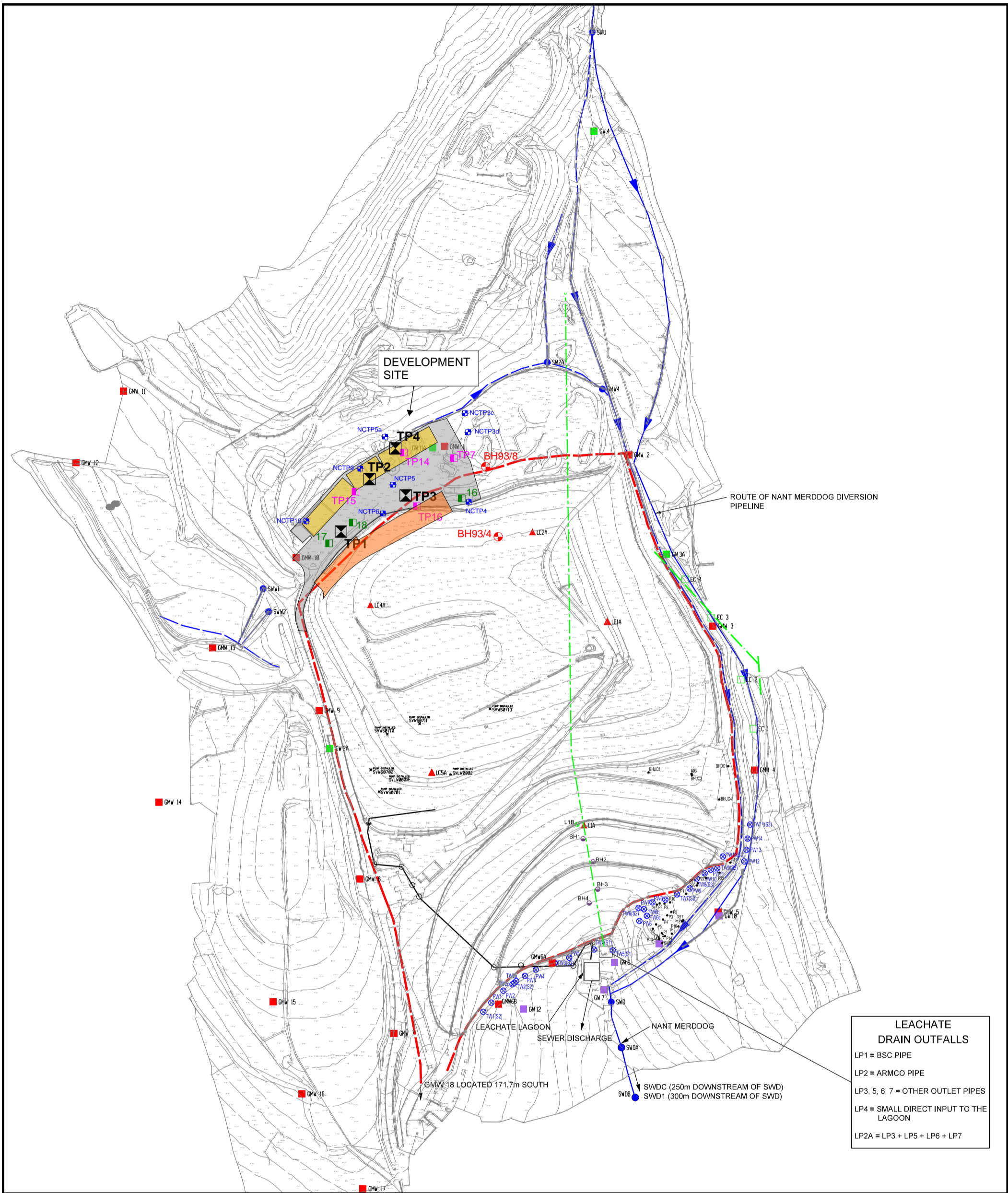

LEGEND

- | | | | | |
|--|------|-------------------------------------|--|--|
| | EC 1 | EASTERN CUT-OFF MONITORING WELLS | | REINFORCED CONCRETE SLAB UNDER CANOPY LOCATION |
| | GMW5 | GAS MONITORING POINTS | | OPEN AIR CONCRETE SLAB LOCATION |
| | GW10 | COMPLIANCE POINT GROUND WATER WELLS | | WASTE TRANSFER STATION LOCATION AND LAYOUT |
| | GW4 | GROUND WATER MONITORING WELLS | | HISTORICAL TRIAL PITS (Nov. 2012) |
| | SW1 | SURFACE WATER SAMPLING POINTS | | HISTORICAL TRIAL PITS (Feb. 1993) |
| | LC1 | LEACHATE MONITORING WELLS | | HISTORICAL TRIAL PITS (Feb. 1996) |
| | | SURFACE WATER DITCHES | | HISTORICAL TRIAL PITS (Dec. 1993) |
| | | EXTENT OF LANDFILLED WASTE | | 'AS-BUILT' TRIAL PIT LOCATIONS |
| | | PUMPING WELL CUT OFF SYSTEM | | |

- LEACHATE DRAIN OUTFALLS**
- LP1 = BSC PIPE
 - LP2 = ARMCO PIPE
 - LP3, 5, 6, 7 = OTHER OUTLET PIPES
 - LP4 = SMALL DIRECT INPUT TO THE LAGOON
 - LP2A = LP3 + LP5 + LP6 + LP7

Silent Valley
 SITE LAYOUT PLAN
 115825-00

FIGURE 2

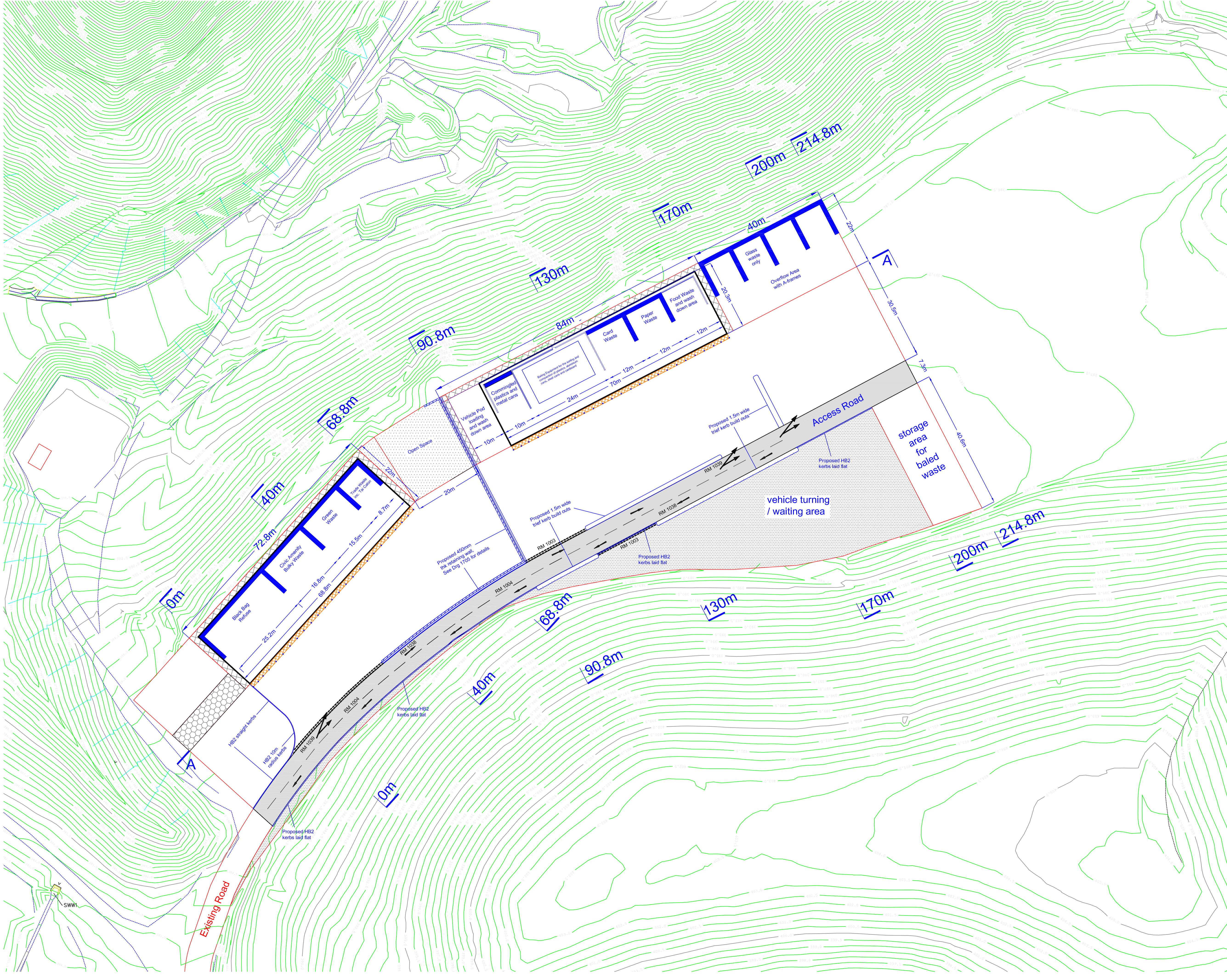

DRG. No. TS0772 / 102 Rev A

ISSUE	AMENDMENTS	DRAWN	CHKD
A	Addition of 450mm thick retaining wall and vehicular barrier to raise the site level, due to the recommendations of ground investigation report.	DR	CP

- Legend:**
- 200 thk Concrete Road Slab
 - 250 thk Concrete Building Slab
 - Vehicle turning / bale storage
 - Proposed 7.3m wide carriage
 - Footpath / Walkways
 - Concrete moveable A-frames
 - Boundary Walls (Rigid)
 - 450mm thk retaining wall
 - 1.2m wide trief kerb build-out
 - Concrete slab for potential of and welfare facilities
 - Open space
 - Hatching (RM 1043) at from building with bollards to prote the columns

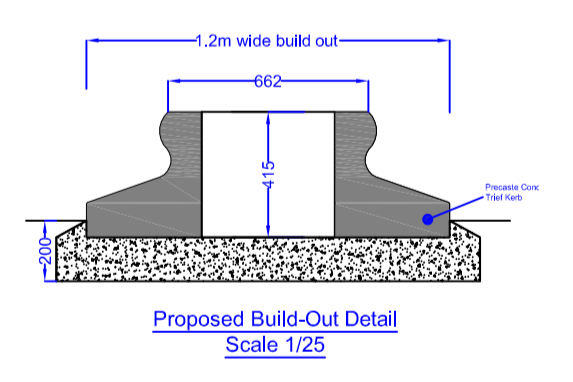
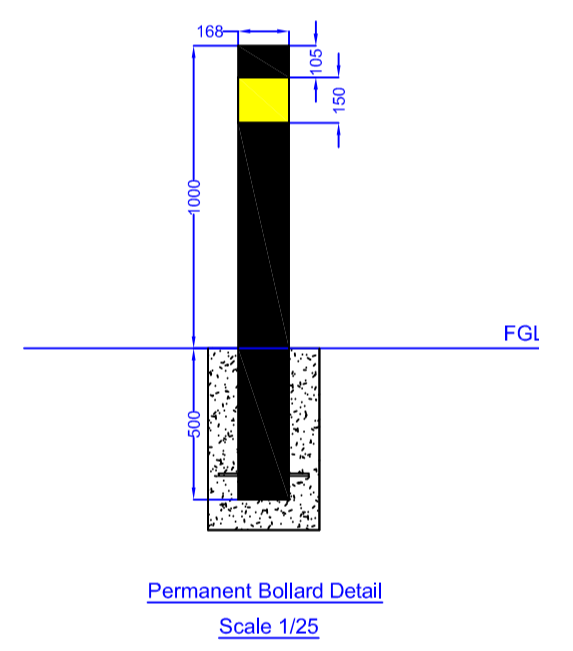

**Silent Valley Waste Transfer Station
Phase 3
Waunlwyd, Ebbw Vale.**

General Arrangement

C. ROGERS B.Sc. (Hons), C.Eng., M.I.C.E., D.M.S., I
CHIEF TECHNICAL OFFICER
ENVIRONMENT DIRECTORATE
BALDWIN HOUSE
VICTORIA BUSINESS PARK
EBBW VALE
NP23 8ED

DRAWN	DR	Apr 15	CHECKED	CP	Ag
SCALE		1:500			
DRG. No.		TS 0772 / 102 Rev A			

ISSUE	AMENDMENTS	DRAWN	CHKD	I

Drainage Notes:

- Existing 450mm dia. storm line.
- Existing 750mm dia. storm line.
- - - Proposed pipe to MH F1 from washdown area
- - - Existing leechate drainage channel.
- - - Proposed leechate drainage channel.
- - - Existing Hydraulic Pumps to South Lagoon.
- F1 Proposed Foul Manhole F1 to replace Lagoon
- Proposed storm manholes.
- - - 300mm dia. UPVC drainage pipe connecting manholes.
- G Proposed access chamber gullies at end of ee run with 200mm dia. pipe connection to manh as supplied by "Althon" or similar approved.
- Proposed Heavy Duty drainage channel 200m wide with linear fall, with heavy duty cast iron grating class E600 as supplied by "Althon or similar approved.
- Petrol interceptor size and specification to be determined by the awarded Contractor. Interceptor must be capable of storing min. 8000m2 of run off water. To be supplied by "Conder Aqua Solutions" or similar approved.

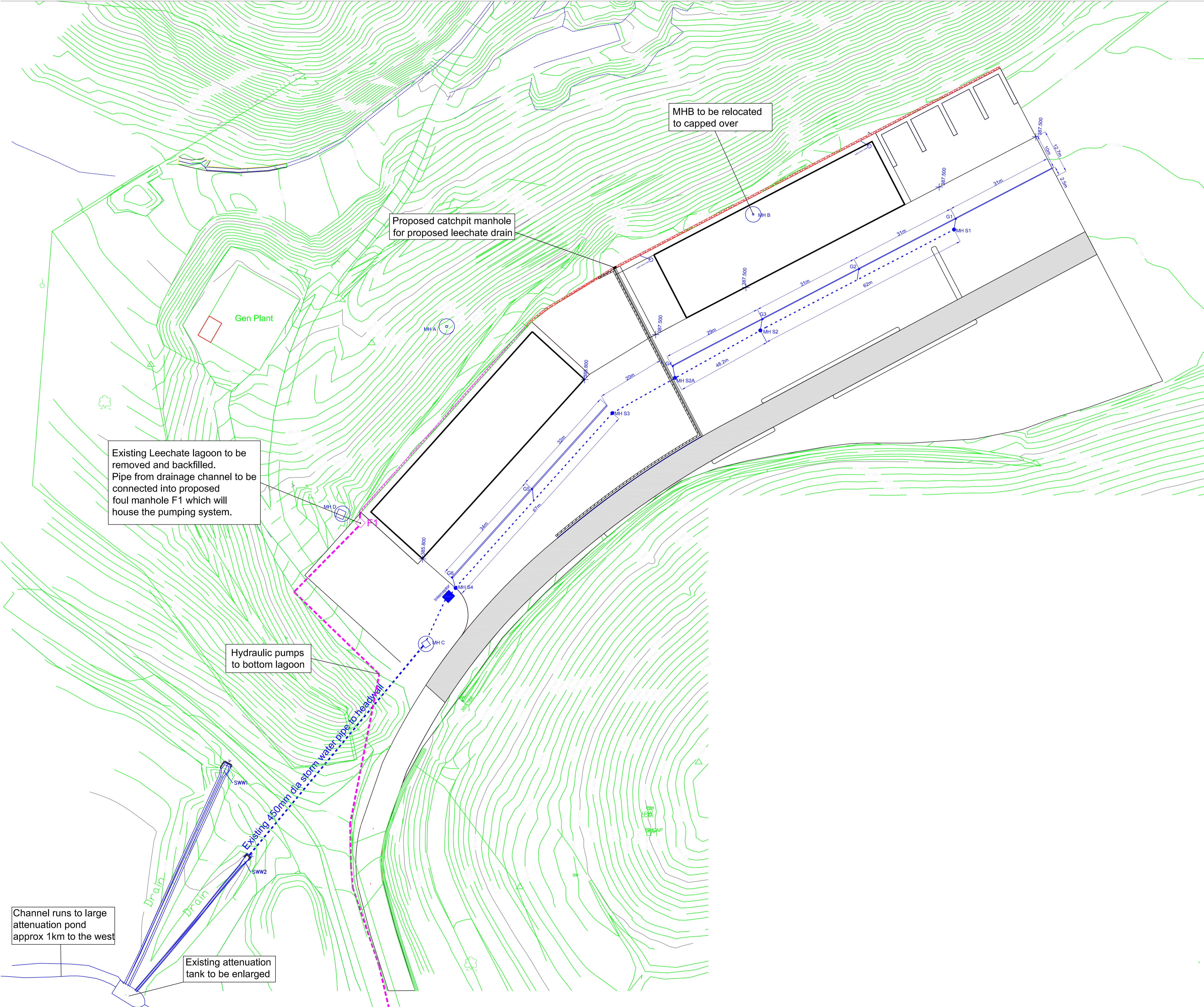

ISSUE	AMENDMENTS	DRAWN	CHKD	I
A	<p>site level raised due to the recommendations of ground investigation report. Additional MHS2A introduced. Relocation works to MHB deleted. MHB to be capped over.</p> <p>Please note cross sections thru' manholes and proposed cover and invert levels have been deleted from this drawing.</p> <p>Revised levels and cross sections will be issued to the awarded contractor.</p>	DR	CP	Z:



Silent Valley Waste Transfer Static Phase 3 Waunlwyd, Ebbw Vale.

Proposed Drainage Layout

C. ROGERS B.Sc. (Hons), C.Eng., M.I.C.E., D.M.S., DI
 CHIEF TECHNICAL OFFICER
 ENVIRONMENT DIRECTORATE
 BALDWIN HOUSE
 VICTORIA BUSINESS PARK
 EBBW VALE
 NP23 8ED

DRAWN	DR	Apr 15	CHECKED	CP	Apr
-------	----	--------	---------	----	-----

SCALE 1:500

Appendix B

Note on ground investigation results, April 2015

4 Pierhead Street
Capital Waterside
Cardiff CF10 4QP
United Kingdom
www.arup.com

t +44 29 2047 3727
f +44 29 2047 2277

Project title	Silent Valley Landfill	Job number	115825-00
cc	Charlie Martin (Arup) Noel Chard (SVWS)	File reference	115825/4-70
Prepared by	Flavia Cappelletti	Date	17 April 2015
Subject	Silent Valley Waste Transfer Station - Ground investigation results		

Silent Valley Waste Transfer Station - Ground investigation results

Introduction

Silent Valley Waste Services (SVWS) are proposing to extend the existing waste transfer station facility located to the north-west of Silent Valley landfill, as shown on **Figure 1**. The location of the proposed development is adjacent to the existing waste transfer station and is located off the landfill.

During the proposed works, it is considered likely that the site operatives involved in the development will come into close contact with material arisings. Excavations across the scheme will include the removal of approximately 1.4m of existing surface material for the installation of gas protection measures and up to 2m at manhole locations. However, the final design is currently not clear and is yet to be confirmed by Blaenau Gwent County Borough Council (BGCBC).

Although the planning permission for the proposed development is yet to be granted, feedback from the Contaminated Land Officer for BGCBC has confirmed the requirement for a ground investigation to assess the risks associated with the site. Other conditions that may be associated with the development have not yet been confirmed.

The following risks associated with the expected ground conditions were identified by Arup based on the review of available information and knowledge of the site and proposed development:

- Presence of made ground, with associated risks to site end users and operatives;
- Presence of slag in the sub-surface, with associated risks to buildings through potential for expansion.

Arup have been appointed by SVWS to undertake works to address the comments by BGCBC with regards to the site risks and confirm the ground conditions at the site. Consequently, Arup scoped a ground investigation including trial pit works and a soil analytical testing suite as further detailed below.

This technical note presents a summary of the fieldworks and the results of the chemical laboratory analyses undertaken as part of the ground investigation, which was carried out on 03/05/2015. A review of the results of the geo-environmental soil analyses has been undertaken to confirm any risks posed to site operatives who may encounter materials during the works. In addition, the results and interpretation of Phase I slag testing have been received, and recommendations are included in this note in regard to further analyses on the slag samples to confirm their potential for expansion.

File Note

115825-00

17 April 2015

Fieldwork

In accordance with the agreed scope of works (Ref. [1]), the following ground investigation was carried out on 03/05/2015 at the site of the proposed extension to the existing waste transfer station facility (see **Figure 1** for TP locations) to confirm the existing ground conditions at the site. Trial pit logs and photographs are presented in Appendix A.

- TP1: excavated to 1.9m depth;
- TP2: excavated to 2.7m depth;
- TP3: excavated to 2.7m depth;
- TP4: excavated to 2.6m depth.

All the trial pit locations were terminated at depths greater than the proposed excavations for the installation of gas protection measures (1.4m). Trial pits TP2, TP3 and TP4 also exceeded the maximum proposed depth of excavation for manhole locations (2m).

A total of 13no. geo-environmental soil samples were obtained from the trial pits, 6no. of which have been submitted to ESG laboratory for chemical analysis. In addition, 9no. soil (bulk bags) samples were obtained for slag testing and submitted to Ian Thomas Research for petrological analysis.

Summary of ground conditions

A summary of the ground conditions encountered in the 4no. trial pits is provided below. A full description of the samples obtained is presented in the logs in Appendix A.

Made ground is present from surface in all the investigated locations and has been proven to a maximum depth and thickness of 2.7m. Made ground is generally dark grey and brown sand and gravel and generally contains slag, construction rubble, plastic, metal and sandstone cobbles. The underlying natural materials were not encountered during the ground investigation, however, based on previous ground investigation information (Ref. [2] and [3] and **Figure 1** for locations), these are expected to be present at depths comprised between approximately 0.5m and 4m beneath the site of the proposed development.

Slight ingress of groundwater was recorded in TP1, TP3 and TP4, whilst no groundwater was encountered in TP2 during the GI. It is understood that the proposed construction excavations are anticipated generally to about 1.4m bgl (up to a maximum of 2m bgl at manhole locations) and, although the ground investigation has suggested negligible inflows, there is potential for groundwater ingress in the excavations required for the construction of the proposed development and groundwater control measures may therefore be required.

Soil analysis results

Soil samples were analysed for a targeted suite of analyses based on the site history and included metals, speciated polycyclic aromatic hydrocarbons (PAHs), speciated total petroleum hydrocarbons, cyanide, phenol, acid-soluble sulphates, sulphides, pH and asbestos (quantification analysis). A full description of the samples obtained and an assessment of the chemical analyses results are presented in Appendix A and B.

In addition to the above, slag samples were subjected to a petrological assessment to confirm their potential for expansion.

Geo-environmental results

A number of geo-environmental soil samples displayed visual and/or olfactory evidence of hydrocarbon contamination during the ground investigation as detailed in the trial pit logs included in Appendix A. These are summarised in **Table 1**.

File Note

115825-00

17 April 2015

Table 1 – Summary of geo-environmental samples displaying visual and/or olfactory evidence of contamination

Trial pit location	Depth of sample	Evidence of contamination
TP1	0.6m	Presence of slag in black soil matrix.
	1.2m	Presence of slag in black soil matrix.
TP2	0.25m	Presence of slag, bricks and fragments of metal, timber, plastic and tin. (stratum as above)
	1.0m	
	1.7m	Presence of slag, bricks, timber, metal, wires in black soil matrix. Strong hydrocarbon odour.
	2.5m	Presence of slag. Strong hydrocarbon odour.
TP3	0.3m	Presence of slag, bricks, plastic, timber, tiles, clothes, construction rubble.
	0.8m	
	1.9m	Presence of slag, bricks, construction rubble, plastic in black soil matrix. (stratum as above)
	2.4m	
TP4	0.6m	Presence of slag, bricks, construction rubble, plastic and metal. Hydrocarbon odour
	1.2m	Presence of slag. Hydrocarbon odour.

The results of the chemical analyses are presented in Appendix B and are summarised in **Table 2** overleaf.

The current design for the proposed development involves the construction of open sheds above hard-standing areas for an industrial/commercial end use. A commercial land use scenario would therefore be appropriate for the assessment of the risks to the site's end users. However, it is considered that the workers involved in the construction operations for the proposed development are the most sensitive receptors and for this reason the results of the chemical analyses have been screened against the residential soil guideline values, which are considered relatively conservative with respect to the proposed development.

Review of the geo-environmental analysis results shows that all contaminant concentrations are below the applied screening criteria (residential land use scenario, based on chronic exposure), with the exception of benzo(a)pyrene (a PAH) in the following samples: TP1 at 0.6m bgl, TP2 at 0.25m bgl, TP3 at 0.3m bgl, TP3 at 0.8m bgl and TP4 at 1.2m bgl. In addition, TPHs were also reported to be relatively elevated in the sample from 0.6m depth in TP4, although no published guideline values are available for TPHs.

Asbestos was detected in concentrations greater than 0.001% in TP2 at 1.7m bgl, TP3 at 0.8m bgl and TP4 at 1.2m bgl typically as chrysotile free fibres and lagging, typically containing about 60% asbestos. Chrysotile free fibres and lagging were also encountered in the coarse/medium soil fraction in the remainder of the samples (TP2 at 0.25m bgl, TP3 at 0.3m bgl and TP1 at 0.6m bgl), although the recorded total concentration of asbestos in these samples was less than 0.001%.

Slag test results

Selected samples of made ground were subject to a suite of tests by Thomas Research Services to investigate the potential for these materials to undergo volumetric expansion. Full details of the testing, results and recommendations from Thomas Research Services Ltd. are contained in presented in Appendix C.

The test revealed the samples to comprise predominantly weathered crystalline blast furnace slag, which may comprise pockets of potentially expansive material. Basic steel slag and basic refractory materials, likely to have significant potential for expansion, were also detected in the samples.

File Note

ARUP

Table 2 – Summary of geo-environmental test results (continued on next page)

Trial pit location	Depth of sample	Analyte:	SO4-- (acid sol)	Arsenic (MS)	Cadmium (MS)	Chromium (MS)	Copper (MS)	Lead (MS)	Manganese (MS)	Mercury (MS)	Nickel (MS)	Selenium (MS)	Zinc (MS)
		Units:	mg/kg	mg/kg	mg/kg	mg/kg	mg/kg	mg/kg	mg/kg	mg/kg	mg/kg	mg/kg	mg/kg
ARUP SGV/GAC (residential)		-		32	10	3000	2330	230	-	170	130	350	3750
ARUP SGV/GAC (commercial)		-		640	230	30400	71700	7300	-	3600	1800	13000	662000
TP2	0.25m		693	9.6	0.2	27.6	30.7	32.9	587	0.1	18.2	0.6	70.5
TP2	1.7m		251	9.7	0.1	25.3	12.6	19.9	565.8	<0.1	17.6	<0.5	50.5
TP3	0.3m		253	8.8	0.12	24.6	13.2	25.1	666.5	<0.1	15.6	<0.5	50
TP3	0.8m		4990	13	1.98	521.2	62.3	153.1	14990	0.34	31.3	1.6	468.3
TP4	1.2m		7170	11.4	1.54	512	49.8	110	10910	0.23	30.5	1.2	362.8
TP1	0.6m		8710	12.8	0.58	1401	38	67.5	10660	0.12	26	2.1	245.7

Trial pit location	Depth of sample	Analyte:	pH units (AR)	Cyanide (Total) (AR)	Asbestos ID and Quantification	TPH by GCFID (AR)	Sulphide as S (AR)	Phenol	Cresols	Xylenols	Trimethyl phenols	Total Phenols	Naphthalene
		Units:	pH Units	mg/kg	%	mg/kg	mg/kg	mg/kg	mg/kg	mg/kg	mg/kg	mg/kg	mg/kg
ARUP SGV/GAC (residential)		-		1.4	-	-	-	184	-	-	-	184	1.5
ARUP SGV/GAC (commercial)		-		16200	-	-	-	3200	-	-	-	3200	76
TP2	0.25m		10.8	<0.5	<0.001	343	<0.5	<0.3	<0.3	<0.3	<0.3	<1.2	0.1
TP2	1.7m		10.7	<0.5	0.008	123	21.4	<0.3	<0.3	<0.3	<0.3	<1.2	0.14
TP3	0.3m		10.5	<0.5	<0.001	295	<0.5	<0.3	<0.3	<0.3	<0.3	<1.2	0.09
TP3	0.8m		8.2	<0.5	0.003	333	7.4	<0.3	<0.3	<0.3	<0.3	<1.2	0.14
TP4	1.2m		9.4	<0.5	0.003	292	<0.5	<0.3	<0.3	<0.3	<0.3	<1.2	0.12
TP1	0.6m		10.7	<0.5	<0.001	12000	31.2	0.7	0.5	0.5	0.2	1.9	0.53

File Note

115825-00

17 April 2015

Trial pit location	Depth of sample	Analyte:	Acenaphthylene	Acenaphthene	Fluorene	Phenanthrene	Anthracene	Fluoranthene	Pyrene	Benzo[a]anthracene	Chrysene	Benzo[b]fluoranthene	Benzo[k]fluoranthene
		Units:	mg/kg	mg/kg	mg/kg	mg/kg	mg/kg	mg/kg	mg/kg	mg/kg	mg/kg	mg/kg	mg/kg
ARUP SGV/GAC (residential)			170	205	163	92	2260	257	563	3.1	6	5.6	8.5
ARUP SGV/GAC (commercial)			84300	84900	63500	21900	525000	22600	54200	90	137	100	141
TP2	0.25m		0.26	<0.08	0.17	3.69	0.68	5.47	3.75	2.24	2.11	2.57	0.8
TP2	1.7m		<0.08	0.09	0.09	0.75	0.16	0.86	0.63	0.48	0.5	0.65	0.27
TP3	0.3m		0.12	<0.08	0.1	1.27	0.3	2.52	1.92	1.7	1.65	2.48	0.86
TP3	0.8m		0.16	<0.08	<0.08	1.02	0.23	2.19	1.59	1.39	1.52	2.31	0.67
TP4	1.2m		0.09	<0.08	<0.08	0.8	0.22	2.01	1.63	1.32	1.51	2.1	0.73
TP1	0.6m		0.14	0.12	0.37	1.89	0.5	2.42	1.67	1.48	1.27	1.49	0.49

Trial pit location	Depth of sample	Analyte:	Benzo[a]pyrene	Indeno[1,2,3-cd]pyrene	Dibenzo[a,h]anthracene	Benzo[g,h,i]perylene	Total USEPA16 PAHs	TPH >C8 - C10	TPH >C10 - C12	TPH >C12 - C16	TPH >C16 - C21	TPH >C21 - C35
		Units:	mg/kg	mg/kg	mg/kg	mg/kg	mg/kg	mg/kg	mg/kg	mg/kg	mg/kg	mg/kg
ARUP SGV/GAC (residential)			0.83	3.2	0.76	44	-	-	-	-	-	-
ARUP SGV/GAC (commercial)			14	60	13	654	-	-	-	-	-	-
TP2	0.25m		1.63	1.33	0.34	1.18	<26.40	<2	<2	4.03	37.9	273
TP2	1.7m		0.42	0.38	0.12	0.32	<5.94	<2	<2	5.69	21.5	84.7
TP3	0.3m		1.22	1.4	0.39	1.2	<17.30	<2	<2	4.76	31.9	225
TP3	0.8m		1.05	1.45	0.38	1.2	<15.46	<2	<2	3.89	41.3	253
TP4	1.2m		1.05	1.35	0.34	1.08	<14.51	<2	<2	3.49	25.2	224
TP1	0.6m		0.93	0.87	0.23	0.64	15.04	6.01	48.5	337	1400	9470

Conclusions and recommendations

Geo-environmental results

The review of the ground investigation results has indicated that the site is suitable for the proposed end use and does not present any unacceptable risk to site end users.

Benzo(a)pyrene (a PAH) has been recorded in excess of the applied screening criteria in three samples of made ground from the investigated area. In addition, the relatively elevated TPHs were recorded in TP4 at 0.6m depth. The presence of hydrocarbon contamination is likely to be associated with landfill refuse and steelworks waste and suggests potential risks to site operatives.

It is recommended that the contractors involved in construction and maintenance works undertake suitable risk assessments to confirm the appropriate health and safety measures including the level of PPE required for site operatives. As a minimum, the following PPE would be expected to be adopted for the duration of the works, in accordance with current good practice:

- protective gloves (nitrile) to be worn at all times;
- eye protection;
- dust mask;
- long-sleeved jackets or overalls.

Welfare facilities should be made available during the works. Smoking or eating should not be undertaken in the locale of the excavations.

It is recommended that the presence of PAHs, TPHs and asbestos (see below) associated with the made ground materials present in the investigated area are recorded in the scheme's risk register so that future maintenance workers are made aware and can manage the risks accordingly.

Asbestos

Asbestos containing materials and detectable levels of asbestos fibres have been identified in the soils underlying the site during the recent ground investigation. As a consequence, the proposed works and working methods will need to incorporate a strategy to address the risks posed by the presence of asbestos.

The assessment and the recommendations provided in this note are based on our current understanding of the contaminated land regime in the UK and specifically the manner in which asbestos in soils is currently regulated. The recently published CIRIA C733 guidance on *Asbestos in soil and made ground: a guide to understanding and managing risk* (Ref. [4]) sets out the regime for assessment and risk management for sites that contain soils or made ground potentially contaminated with asbestos. The guidance also provides supports in compliance with the legislation including Part 2A and planning regime, and the Control of Asbestos Regulations 2012 (Ref. [5]). C733 highlights there are a number of scientific uncertainties on the methods for assessing asbestos in soils and that some further guidance on policy in the UK is required.

The Health and Safety Executive (HSE) has confirmed that asbestos in soils is regulated by the CAR 2012. The HSE have published a code of practice in 2013, *Managing and working with Asbestos. Control of Asbestos Regulations 2012. Approved Code of Practice and guidance* (Ref. [6]), which includes specific guidance in working with asbestos. The HSE and Environment Agency (EA) are currently preparing a document as to how asbestos in soils will be regulated under CAR 2012 which is expected to be published in 2015. In addition, the Joint Industry Working Group (JIWG) on asbestos in soil is expected to publish a code of practice in 2015. Any proposed strategy will need to be reviewed with respect to these documents should they be published before works progress.

It is common practice to include asbestos containing soils (ACS) within cut/fill earthworks if demonstrated by a risk-based assessment to be acceptable for the end use of the development and if the works are undertaken in a manner which prevents exposure to workers and neighbours. There is currently some debate

File Note

115825-00

17 April 2015

if the use of ACS contravenes the UK and EC prohibitions on the use of asbestos in construction and that has specifically not be clarified at this time. The EA published updated guidance, *Hazardous Waste: Interpretation of the definition and classification of hazardous waste* (Ref. [7]), which clarifies the process of classifying waste soils as hazardous waste (if they are disposed as waste).

The following recommendations are made with regards to the encountered contamination on the site:

1. In general, soils on the site and those to be subject to earthworks are considered acceptable with respect to the proposed end use of the site subject to implementation of remedial and mitigation measures as discussed below.
2. Elevated levels of PAHs have been encountered within the soils. As discussed, it is considered that appropriate PPE during the construction works in addition to the mitigation measures introduced in relation to asbestos will be sufficient to mitigate these risks.
3. It is not considered acceptable that the encountered concentrations of asbestos exist at or near surface level in areas of open ground. However, the risk of exposure to asbestos after development is considered to be negligible as the development comprises concrete slabs and hard-standing across the development area and there are no areas of open landscaping. Should this change, then a review of the applied strategy is recommended.
4. Site-won soils during earthworks may be used on site beneath buildings and in areas of hard-standing.
5. If suspected contamination is encountered in the material excavated during the earthworks, then this material will require appropriate testing before it is used, in order to identify whether it can be used as the above general fill below buildings or hard-standings, or requires further treatment and/or disposal.
6. Service trenches and corridors that may require future maintenance shall be provided with clean backfill. A specification for this should be agreed with the Regulatory Authorities, an example specification is provided in **Table 3** overleaf.
7. A watching brief is to be maintained through all earthworks on the site for unsuitable or unexpected conditions (including ACM) and to ensure the various recommendations provided are implemented and recorded. The watching brief will be documented, reported on during progress meetings and compiled in a verification report. The watching brief shall not necessarily involve specialist personnel (although staff will be specifically briefed and competent to carry out the brief), and it will be defined on site, communicated to staff involved in the ground works (through tool box talks etc.) and reported on. All works involving testing and assessment will be undertaken by suitably qualified and experienced personnel.
8. The earthworks contractor will appoint a specialist asbestos contractor to advise on works with ACM in accordance with current guidance (Ref. [4], [5] and [6]). The appointed specialist will be provided with all asbestos analyses results to-date as obtained during the site investigation. Works specifically involving asbestos materials and air monitoring will be undertaken under the supervision of appropriate experienced personnel. The specialist will complete the initial CAR 2012 assessment to determine the status of the works and whether they are non-licensed, notifiable non-licensed or licensed works, and therefore the appropriate level of control. Further measures are defined below.
9. Asbestos fibres were identified during laboratory analyses in samples obtained from across the site, at varying depth as discussed above. Suspected asbestos lagging was encountered in one location during the intrusive investigations works. It may not be practical to identify and segregate all such material during earthworks and should visible pieces of ACM or particular asbestos hotspots be encountered, these shall be segregated, stored, and disposed of where practical to do so.

File Note

115825-00

17 April 2015

Table 3 - Specification for capping soils and backfill to service trenches

Parameter	Unit	Capping Soil
Arsenic	mg/kg	40
Cadmium	mg/kg	149
Chromium	mg/kg	3000
Copper*	mg/kg	200
Lead	mg/kg	310
Nickel*	mg/kg	110
Mercury	mg/kg	11
Selenium	mg/kg	350
Zinc*	mg/kg	300
Asbestos**	% w/w	Absent
Total Cyanide	mg/kg	1.4
Phenol	mg/kg	420
Benzene	mg/kg	0.330
Toluene	mg/kg	610
Ethylbenzene	mg/kg	350
Xylene	mg/kg	250
Total Petroleum Hydrocarbons***	mg/kg	500
TPH Aliphatic C5-C6	mg/kg	30
TPH Aliphatic C6-C8	mg/kg	73
TPH Aliphatic C8-C10	mg/kg	19
TPH Aliphatic C10-C12	mg/kg	69
TPH Aromatic C5-C7	mg/kg	65
TPH Aromatic C7-C8	mg/kg	120
TPH Aromatic C8-C10	mg/kg	27
TPH Aromatic C10-C12	mg/kg	69
TPH Aromatic C12-C16	mg/kg	140
TPH Aromatic C16-C21	mg/kg	250
Acenaphthene	mg/kg	210
Acenaphthylene	mg/kg	170
Anthracene	mg/kg	2300
Benzo(a)anthracene	mg/kg	3.1
Benzo(a)pyrene	mg/kg	5.3
Benzo(b)fluoranthene	mg/kg	5.6
Benzo(ghi)perylene	mg/kg	44
Benzo(k)fluoranthene	mg/kg	8.5
Chrysene	mg/kg	6
Dibenzo(ah)anthracene	mg/kg	0.76
Fluoranthene	mg/kg	260
Fluorene	mg/kg	160
Indeno(123cd)pyrene	mg/kg	3.2
Naphthalene	mg/kg	1.5
Phenanthrene	mg/kg	92
Pyrene	mg/kg	560

Notes:

*Acceptance criteria set at topsoil BS3882:2007.

**Analysis will be sufficient to confirm the absence of asbestos to a detection limit of 0.001%. Laboratories must have UKAS accreditation to ISO 17025 for the identification of asbestos. QC schemes should comply with LAB 30 and HSG 248. The whole as received sample (1kg or less) is initially examined visually to identify the presence of ACMs and fibres/fibre bundles, with a dried subsample being examined by stereomicroscopy (x20 and x40 magnification).

File Note

115825-00

17 April 2015

*** Not excluding the individual petroleum compounds criteria; No soils exhibiting any visual or olfactory evidence of hydrocarbon contamination may be used as capping materials; No materials exhibiting significant evidence of hydrocarbon contamination may be reused within the scheme.

Site Safety and Control

Work with asbestos in the UK is controlled by the HSE and the CAR 2012 (Control of Asbestos Regulations, Ref. [5]). The contractor should undertake specific assessments and mitigation described in the CAR.

Although the contractor will be responsible for confirming the appropriate mitigation strategy and working methods, it is envisaged that the following mitigation measures shall be implemented during the works:

1. Due to the presence of asbestos in soils, the works shall be undertaken in a fashion to prevent the creation of dusts. All made ground shall be kept damp when being handled, particularly during the proposed earthworks and when exposed at the surface. Sufficient wetting procedures shall be in place, such as misters or sprays depending on the prevailing weather conditions and proposed activities. Dust prevention measures must be proactive and be in place before work commences and surfaces wetted before and during earthworks. This should include access roads and stockpiles as well as soils being excavated.
2. Boundary and representative personnel air/dust monitoring shall be undertaken during work with made ground to confirm the absence of fibre release and exposure during the works. A selection of staff involved in the earthworks shall be subject to air monitoring for dust and asbestos fibres. The boundary monitoring shall be set up before excavation/earthworks works start (to measure background levels) then continued periodically during the earthworks. Boundary air monitoring should be undertaken to a suitable detection limit to demonstrate that there is no appreciable risk to off-site receptors, or those on site during phased development.
3. Sufficient hygiene units and PPE shall be provided for the works.
4. Suitably competent personnel shall advise on and supervise the works.
5. All staff should be briefed on the working methods including appropriate asbestos awareness training.
6. If vehicles entering or leaving the site will come into contact with potentially contaminated made ground, then a robust wheel wash system shall be in place to prevent the spread of contamination off-site.
7. The Contaminated Land Officer at BGCBC shall be notified prior to the onset of the proposed earthworks.

Slag test results

The review of the petrology testing of the slag gravel has indicated that the main slag constituent is blast furnace slag and that there is potential for slag expansion (see Appendix C), albeit that blast furnace slag is less susceptible to expansion than other slags such as refractory slags. Considering the low sensitivity of the development to minor differential movement, i.e. the development is essentially an open shed on a slab, any movement due to slag expansion is unlikely to present a significant issue and therefore it is not considered that further slag property testing would provide tangible benefit.

Review of the proposed development suggests that the most sensitive issue would be movement of the proposed pad foundations for the portal frames and therefore BGCBC may consider it of benefit to remove the made ground materials down to natural ground (estimated as approx. 3.5mbgl) local to these, and then backfill with a geotechnically suitable engineering fill.

File Note

115825-00

17 April 2015

Re Use of Site Won Materials

It is understood that the current outline design may result in some 9000m³ of soil arisings that will not be required for the development. In accordance with current waste management guidance these arisings will be considered to be waste unless there is a definite use identified for them, for which the materials will be considered to be suitable for. Considering the presence of low levels of asbestos and other contaminants it is not considered that these materials will be suitable for re use in areas of open landscaping, however they are likely to be acceptable to be used beneath a capping layer – be it soil or hardstanding – on another part of development. In order to facilitate any re use of soils it is recommended that a materials management plan is prepared in accordance with the CL:aire Definition of Waste Code of Practice Ref. [8].

References

- [1] Ove Arup and Partners Ltd, File Note, Silent Valley Landfill, Silent Valley Waste Transfer Station – Ground investigation proposals, 23rd February 2015
- [2] Silent Valley Waste Services Ltd, Historical records of boreholes, trial pits and trial trenches at Silent Valley Landfill site, Version 1, April 2005
- [3] Ove Arup and Partners Ltd, Trial pit logs for the northern cut-off, November 2012
- [4] CIRIA, Asbestos in soil and made ground: a guide to understanding and managing risk (C733), March 2014
- [5] Statutory Instrument, Control of Asbestos Regulations No. 632, No. 632 April 2012
- [6] Managing and working with Asbestos. Control of Asbestos Regulations 2012. Approved Code of Practice and guidance. L143, 2nd edition, HSE, 2013
- [7] Technical guidance WM2, Hazardous Waste: Interpretation of the definition and classification of hazardous waste, 3rd edition, May 2013
- [8] The Definition of Waste: Development Industry Code of Practice, Version 2, CL:AIRE, March 2011

List of Appendices

Appendix A - Trial pit logs and photographs

Appendix B - Chemical analyses results (ESG)

Appendix C – Slag testing results and recommendations (Thomas Research Services Ltd.)

List of Figures

Figure 1 – Silent Valley, General site layout

DOCUMENT CHECKING (not mandatory for File Note)

	Prepared by	Checked by	Approved by
Name	Flavia Cappelletti	Charlie Martin	Charlie Martin
Signature			

Appendix A

Trial pit logs and photographs

<h1>ARUP</h1>	Location: Silent Valley Waste Transfer Station	Project No: 115825
		Project Name: Silent Valley Lanfill
www.arup.com		Client: Blaenau Gwent CBC
Trial Pit Log NEVER ENTER A PIT WITHOUT FOLLOWING ALL NECESSARY SAFETY PROCEDURES: SEE ARUP GI R.E. BRIEFING KIT		Date & time: 05/03/2015
		TP ID: TP1
		Logged by: FC
		Ground Level: Approx. 386m OD
		Eastings: -
	Northing: -	Datum: -



Depth	Sketch of Trial Pit Faces			

Strata depth From - to	Legend	Description of Soil: Consistency/density, discontinuities, bedding, color, PRINCIPAL SOIL, secondary constituents (frequency, type & spacing / size), minor constituents (frequency, type & spacing / size)	Dilatancy	Toughness	Plasticity	Strength	Samples		
							Depth	Type	No.
0 - 0.5		Loose light brown clayey/silty sand and gravel with rare cobbles of sandstone and slag							
0.5 - 1.4		Black slightly dense sand/gravel with frequent cobbles and boulders of slag (slag ~70%-80% of total)					0.6m	ES	1
							0.7m	SL	1
1.4 - 1.9		Black loose sand/gravel with frequent cobbles of slag (~70% of total)					1.2m	SL	2

In situ Testing (BGL)				Trial pit ends at 1.9m depth on Engineer's instruction.			
Type	Depth	ID	Results (Units)	Groundwater ingress recorded at 0.5m depth.			
-	-	-	-	Groundwater (BGL)			
				Depth of pit	Depth of strike	Inflow rate	Water depth after 5/10/20 mins
				-	-	-	-
				Contamination: Black staining below 0.5m depth.			
				Dewatering: No			
				Shoring: No			
				Hard Strata: No			
Contractor:	SVWS			Breaking out: No			
Method of excavation:	JCB			Photos: see attached.			
Dimensions (units):	Approx. 1m x 2m			Stability: Stable			
Excavation:	moderate			Similarity: All sides similar			
Weather:	Overcast / drizzle / windy			Backfill: Arisings			

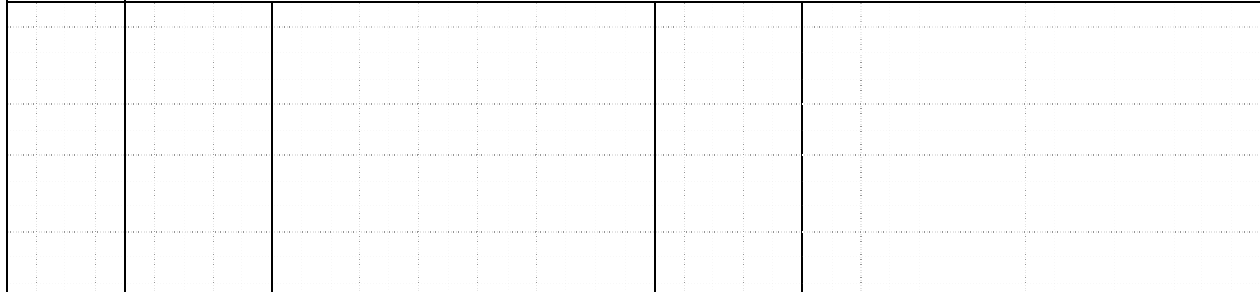
<h1 style="text-align: center;">ARUP</h1> <p style="text-align: center;">www.arup.com</p>		Location: Silent Valley Waste Transfer Station		Project No: 115825 Project Name: Silent Valley Lanfill Client: Blaenau Gwent CBC Date & time: 05/03/2015 TP ID: TP3 Logged by: FC Ground Level: Approx. 386m OD Eastings: - Northing: - Datum: -					
		Trial Pit Log NEVER ENTER A PIT WITHOUT FOLLOWING ALL NECESSARY SAFETY PROCEDURES: SEE ARUP GI R.E. BRIEFING KIT							
Depth		Sketch of Trial Pit Faces							
									
Strata depth From - to	Legend	Description of Soil: Consistency/density, discontinuities, bedding, color, PRINCIPAL SOIL, secondary constituents (frequency, type & spacing / size), minor constituents (frequency, type & spacing/ size)	Dilatancy	Toughness	Plasticity	Strength	Samples		
							Depth	Type	No.
0 - 0.8		Loose brown sandy gravel of sandstone and slag with frequent cobbles of sandstone, slag, bricks, plastic, timber, tiles, clothes, construction rubble. Slag ~70% of total composition. Slag boulders up to 30x20x20cm Frequent bricks below 0.6m Becoming grey below 0.7m Hydrocarbon odour below 0.7m bgl.					0.3m	ES	1
							0.7m	SL	1
0.8 - 1.7		Loose dark grey/black sandy gravel of slag, bricks and sandstone. Occasional cobbles of slag up to 20x30x10cm in size. Strong hydrocarbon odour.					0.8m	ES	2
1.7 - 2.7		Loose black very sandy gravel of slag, bricks, sandstone, construction rubble and plastic. Slag is less frequent - say approx 30% of total.					1.9m	ES	3
							1.9m	SL	2
							2.4m	ES	4
In situ Testing (BGL)			Trial pit ends at 2.7m depth on Engineer's instruction.						
Type	Depth	ID	Results (Units)		Groundwater ingress recorded at 0.5m depth.				
-	-	-	-		Groundwater (BGL)				
			Depth of pit	Depth of strike	Inflow rate	Water depth after 5/10/20 mins			
			-	-	-	-	-	-	-
			Contamination: Strong hydrocarbon odour between 0.7 and 1.7m depth.						
			Dewatering: No						
			Shoring: No						
			Hard Strata: No						
Contractor: SVWS			Breaking out: No						
Method of excavation: JCB			Photos: see attached.						
Dimensions (units): Approx. 1m x 2m			Stability: Stable						
Excavation: easy			Similarity: All sides similar						
Weather: Overcast / drizzle / windy			Backfill: Arisings						

<h1>ARUP</h1>	Location: Silent Valley Waste Transfer Station	Project No: 115825 Project Name: Silent Valley Lanfill Client: Blaenau Gwent CBC Date & time: 05/03/2015 TP ID: TP4 Logged by: FC Ground Level: Approx. 386m OD Eastings: - Northing: - Datum: -
www.arup.com		
Trial Pit Log <small>NEVER ENTER A PIT WITHOUT FOLLOWING ALL NECESSARY SAFETY PROCEDURES: SEE ARUP GI R.E. BRIEFING KIT</small>		

Depth	Sketch of Trial Pit Faces			

Strata depth From - to	Legend	Description of Soil: Consistency/density, discontinuities, bedding, color, PRINCIPAL SOIL, secondary constituents (frequency, type & spacing / size), minor constituents (frequency, type & spacing/ size)	Dilatancy	Toughness	Plasticity	Strength	Samples		
							Depth	Type	No.
0 - 1.2 (East side of pit)		Loose light brown sandy gravel with frequent cobbles. Gravel and cobbles of slag, bricks, construction rubble, plastic and metal (~70% slag). Hydrocarbon odour noted.					0.6m	ES	1
0 - 1.6 (West side of pit)							0.7m	SL	1
1.2 (E) - 2.6		Loose grey/dark brown gravelly cobbles and boulders of slag (~80% slag). Boulders up to 70x70x30cm. Hydrocarbon odour noted.					1.2m	ES	2
1.6 (W) - 2.6							1.7m	SL	2

Insitu Testing (BGL)				Trial pit ends at 2.6m depth on Engineer's instruction.			
Type	Depth	ID	Results (Units)	Slight groundwater ingress recorded from 0.6m depth.			
-	-	-	-	Groundwater (BGL)			
				Depth of pit	Depth of strike	Inflow rate	Water depth after 5/10/20 mins
				-	-	-	-
				Contamination: Hydrocarbon odour noted below 1.4m depth.			
				Dewatering: No			
				Shoring: No			
				Hard Strata: No			
Contractor: SVWS				Breaking out: No			
Method of excavation: JCB				Photos: see attached.			
Dimensions (units): Approx. 1m x 2m				Stability: Stable			
Excavation: easy				Similarity: See description.			
Weather: Overcast / drizzle / windy				Backfill: Arisings			

Appendix B – Selected photographs from ground investigation



Photograph 1 – Trial pit TP1



Photograph 2 – Trial pit TP1 (arisings)



Photograph 3 – Trial pit TP2



Photograph 4 – Trial pit TP2 (arisings)



Photograph 5 – Trial pit TP3



Photograph 6 – Trial pit TP3 (arisings)



Photograph 7 – Trial pit TP4



Photograph 8 – Trial pit TP4 (arisings)

Appendix B

Chemical analyses results (ESG)

Our Ref: EFS/151897 (Ver. 1)

Your Ref:

March 23, 2015



Environmental Chemistry

ESG

Bretby Business Park

Ashby Road

Burton-on-Trent

Staffordshire

DE15 0YZ

Telephone: 01283 554400

Facsimile: 01283 554422

Ms F Cappelletti
Arup
4 Pierhead Street
Capital Waterside
Cardiff
CF10 4QP

For the attention of Ms F Cappelletti

Dear Ms Cappelletti

Sample Analysis - Silent Valley Waste Services

Samples from the above site have been analysed in accordance with the schedule supplied.
The sample details and the results of analyses for these samples are given in the appended report.

An invoice for this work will follow under a separate cover.

Where appropriate the samples will be kept until 22/04/15 when they will be discarded. Please call 01283 554647 for an extension of this date.

Please be aware that our policy for the retention of paper based laboratory records and analysis reports is 6 years.

The work was carried out in accordance with Environmental Scientifics Group Ltd (Multi-Sector Services) Standard Terms and Conditions of Contract.

If I can be of any further assistance please do not hesitate to contact me.

Yours sincerely

for ESG

A handwritten signature in black ink, appearing to read 'C Higgins-Jones', written in a cursive style.

C Higgins-Jones
Project Co-ordinator
01283 554647

TEST REPORT



Report No. EFS/151897 (Ver. 1)

Arup
4 Pierhead Street
Capital Waterside
Cardiff
CF10 4QP

Site: Silent Valley Waste Services

The 6 samples described in this report were registered for analysis by ESG on 11-Mar-2015. This report supersedes any versions previously issued by the laboratory.

The analysis was completed by: 23-Mar-2015

Tests where the accreditation is set to N or No, and any individual data items marked with a * are not UKAS accredited. Opinions and interpretations expressed herein are outside the scope of UKAS accreditation.

The following tables are contained in this report:

- Table 1 Main Analysis Results (Pages 2 to 3)
- Table of PAH (MS-SIM) (80) Results (Pages 4 to 9)
- Table of TPH Texas banding (std) (Page 10)
- GC-FID Chromatograms (Pages 11 to 16)
- Table of Asbestos Results (Page 17)
- Analytical and Deviating Sample Overview (Page 18)
- Table of Method Descriptions (Page 19)
- Table of Report Notes (Page 20)
- Table of Sample Descriptions (Appendix A Page 1 of 1)

On behalf of
ESG :
Declan Burns

A handwritten signature in black ink, appearing to read 'Declan Burns'.

Managing Director
Multi-Sector Services

Date of Issue: 23-Mar-2015

Tests marked 'N' have been subcontracted to another laboratory.

Where samples have been flagged as deviant on the Analytical and Deviating Sample Overview, for any reason, the data may not be representative of the sample at the point of sampling and the validity of the data may be affected.

ESG accepts no responsibility for any sampling not carried out by our personnel.

Where individual results are flagged see report notes for status.

Polycyclic Aromatic Hydrocarbons GC/MS (SIM)

Customer and Site Details:	Arup: Silent Valley Waste Services		
Sample Details:	TP2 0.25	Job Number:	S15_1897
LIMS ID Number:	CL1542235	Date Booked in:	11-Mar-15
QC Batch Number:	150254	Date Extracted:	14-Mar-15
Quantitation File:	Initial Calibration	Date Analysed:	16-Mar-15
Directory:	1615PAH.GC5\	Matrix:	Soil
Dilution:	1.0	Ext Method:	Ultrasonic

UKAS accredited?: Yes

Target Compounds	CAS #	R.T. (min)	Concentration mg/kg	% Fit
Naphthalene	91-20-3	3.21	0.10	97
Acenaphthylene	208-96-8	4.24	0.26	91
Acenaphthene	83-32-9	-	< 0.08	-
Fluorene	86-73-7	4.73	0.17	95
Phenanthrene	85-01-8	5.55	3.69	99
Anthracene	120-12-7	5.61	0.68	98
Fluoranthene	206-44-0	6.88	5.47	94
Pyrene	129-00-0	7.16	3.75	93
Benzo[a]anthracene	56-55-3	8.84	2.24	97
Chrysene	218-01-9	8.89	2.11	100
Benzo[b]fluoranthene	205-99-2	10.37	2.57	83
Benzo[k]fluoranthene	207-08-9	10.40	0.80	83
Benzo[a]pyrene	50-32-8	10.79	1.63	96
Indeno[1,2,3-cd]pyrene	193-39-5	12.18	1.33	87
Dibenzo[a,h]anthracene	53-70-3	12.20	0.34	92
Benzo[g,h,i]perylene	191-24-2	12.47	1.18	94
Total (USEPA16) PAHs	-	-	< 26.40	-

"M" denotes that % fit has been manually interpreted

Internal Standards	% Area
1,4-Dichlorobenzene-d4	NA
Naphthalene-d8	96
Acenaphthene-d10	94
Phenanthrene-d10	94
Chrysene-d12	102
Perylene-d12	112

Surrogates	% Rec
Nitrobenzene-d5	NA
2-Fluorobiphenyl	94
Terphenyl-d14	77

Concentrations are reported on a wet weight basis.

The Total PAH result is the sum of non-rounded individual PAH results and therefore may differ to the sum of the rounded individual PAH results printed above. By convention, where any one or more result is a "less than", the total is expressed as a "less than" and includes the "less than" concentration within the total.

Polycyclic Aromatic Hydrocarbons GC/MS (SIM)

Customer and Site Details:	Arup: Silent Valley Waste Services		
Sample Details:	TP2 1.70	Job Number:	S15_1897
LIMS ID Number:	CL1542236	Date Booked in:	11-Mar-15
QC Batch Number:	150254	Date Extracted:	14-Mar-15
Quantitation File:	Initial Calibration	Date Analysed:	16-Mar-15
Directory:	1615PAH.GC5\	Matrix:	Soil
Dilution:	1.0	Ext Method:	Ultrasonic

UKAS accredited?: Yes

Target Compounds	CAS #	R.T. (min)	Concentration mg/kg	% Fit
Naphthalene	91-20-3	3.21	0.14	99
Acenaphthylene	208-96-8	-	< 0.08	-
Acenaphthene	83-32-9	4.36	0.09	96
Fluorene	86-73-7	4.73	0.09	95
Phenanthrene	85-01-8	5.56	0.75	99
Anthracene	120-12-7	5.61	0.16	98
Fluoranthene	206-44-0	6.88	0.86	95
Pyrene	129-00-0	7.16	0.63	95
Benzo[a]anthracene	56-55-3	8.84	0.48	96
Chrysene	218-01-9	8.89	0.50	99
Benzo[b]fluoranthene	205-99-2	10.37	0.65	93
Benzo[k]fluoranthene	207-08-9	10.40	0.27	94
Benzo[a]pyrene	50-32-8	10.79	0.42	96
Indeno[1,2,3-cd]pyrene	193-39-5	12.18	0.38	82
Dibenzo[a,h]anthracene	53-70-3	12.21	0.12	81
Benzo[g,h,i]perylene	191-24-2	12.47	0.32	83
Total (USEPA16) PAHs	-	-	< 5.94	-

"M" denotes that % fit has been manually interpreted

Internal Standards	% Area
1,4-Dichlorobenzene-d4	NA
Naphthalene-d8	97
Acenaphthene-d10	95
Phenanthrene-d10	94
Chrysene-d12	99
Perylene-d12	105

Surrogates	% Rec
Nitrobenzene-d5	NA
2-Fluorobiphenyl	104
Terphenyl-d14	84

Concentrations are reported on a wet weight basis.

The Total PAH result is the sum of non-rounded individual PAH results and therefore may differ to the sum of the rounded individual PAH results printed above. By convention, where any one or more result is a "less than", the total is expressed as a "less than" and includes the "less than" concentration within the total.

Polycyclic Aromatic Hydrocarbons GC/MS (SIM)

Customer and Site Details:	Arup: Silent Valley Waste Services		
Sample Details:	TP3 0.30	Job Number:	S15_1897
LIMS ID Number:	CL1542237	Date Booked in:	11-Mar-15
QC Batch Number:	150254	Date Extracted:	14-Mar-15
Quantitation File:	Initial Calibration	Date Analysed:	16-Mar-15
Directory:	1615PAH.GC5\	Matrix:	Soil
Dilution:	1.0	Ext Method:	Ultrasonic

UKAS accredited?: Yes

Target Compounds	CAS #	R.T. (min)	Concentration mg/kg	% Fit
Naphthalene	91-20-3	3.21	0.09	98
Acenaphthylene	208-96-8	4.24	0.12	93
Acenaphthene	83-32-9	-	< 0.08	-
Fluorene	86-73-7	4.73	0.10	91
Phenanthrene	85-01-8	5.56	1.27	99
Anthracene	120-12-7	5.60	0.30	99
Fluoranthene	206-44-0	6.88	2.52	94
Pyrene	129-00-0	7.16	1.92	94
Benzo[a]anthracene	56-55-3	8.84	1.70	95
Chrysene	218-01-9	8.89	1.65	97
Benzo[b]fluoranthene	205-99-2	10.37	2.48	96
Benzo[k]fluoranthene	207-08-9	10.40	0.86	96
Benzo[a]pyrene	50-32-8	10.79	1.22	95
Indeno[1,2,3-cd]pyrene	193-39-5	12.17	1.40	87
Dibenzo[a,h]anthracene	53-70-3	12.20	0.39	83
Benzo[g,h,i]perylene	191-24-2	12.47	1.20	92
Total (USEPA16) PAHs	-	-	< 17.30	-

"M" denotes that % fit has been manually interpreted

Internal Standards	% Area
1,4-Dichlorobenzene-d4	NA
Naphthalene-d8	94
Acenaphthene-d10	93
Phenanthrene-d10	93
Chrysene-d12	102
Perylene-d12	114

Surrogates	% Rec
Nitrobenzene-d5	NA
2-Fluorobiphenyl	97
Terphenyl-d14	78

Concentrations are reported on a wet weight basis.

The Total PAH result is the sum of non-rounded individual PAH results and therefore may differ to the sum of the rounded individual PAH results printed above. By convention, where any one or more result is a "less than", the total is expressed as a "less than" and includes the "less than" concentration within the total.

Polycyclic Aromatic Hydrocarbons GC/MS (SIM)

Customer and Site Details: Arup: Silent Valley Waste Services
Sample Details: TP3 0.80 **Job Number:** S15_1897
LIMS ID Number: CL1542238 **Date Booked in:** 11-Mar-15
QC Batch Number: 150254 **Date Extracted:** 14-Mar-15
Quantitation File: Initial Calibration **Date Analysed:** 16-Mar-15
Directory: 1615PAH.GC5\ **Matrix:** Soil
Dilution: 1.0 **Ext Method:** Ultrasonic

UKAS accredited?: Yes

Target Compounds	CAS #	R.T. (min)	Concentration mg/kg	% Fit
Naphthalene	91-20-3	3.20	0.14	97
Acenaphthylene	208-96-8	4.24	0.16	97
Acenaphthene	83-32-9	-	< 0.08	-
Fluorene	86-73-7	-	< 0.08	-
Phenanthrene	85-01-8	5.56	1.02	99
Anthracene	120-12-7	5.61	0.23	94
Fluoranthene	206-44-0	6.88	2.19	94
Pyrene	129-00-0	7.16	1.59	93
Benzo[a]anthracene	56-55-3	8.84	1.39	94
Chrysene	218-01-9	8.89	1.52	100
Benzo[b]fluoranthene	205-99-2	10.37	2.31	94
Benzo[k]fluoranthene	207-08-9	10.41	0.67	94
Benzo[a]pyrene	50-32-8	10.80	1.05	97
Indeno[1,2,3-cd]pyrene	193-39-5	12.18	1.45	69
Dibenzo[a,h]anthracene	53-70-3	12.21	0.38	84
Benzo[g,h,i]perylene	191-24-2	12.47	1.20	93
Total (USEPA16) PAHs	-	-	< 15.46	-

"M" denotes that % fit has been manually interpreted

Internal Standards	% Area
1,4-Dichlorobenzene-d4	NA
Naphthalene-d8	88
Acenaphthene-d10	89
Phenanthrene-d10	93
Chrysene-d12	104
Perylene-d12	113

Surrogates	% Rec
Nitrobenzene-d5	NA
2-Fluorobiphenyl	101
Terphenyl-d14	84

Concentrations are reported on a wet weight basis.

The Total PAH result is the sum of non-rounded individual PAH results and therefore may differ to the sum of the rounded individual PAH results printed above. By convention, where any one or more result is a "less than", the total is expressed as a "less than" and includes the "less than" concentration within the total.

Polycyclic Aromatic Hydrocarbons GC/MS (SIM)

Customer and Site Details:	Arup: Silent Valley Waste Services		
Sample Details:	TP4 1.20	Job Number:	S15_1897
LIMS ID Number:	CL1542239	Date Booked in:	11-Mar-15
QC Batch Number:	150254	Date Extracted:	14-Mar-15
Quantitation File:	Initial Calibration	Date Analysed:	16-Mar-15
Directory:	1615PAH.GC5\	Matrix:	Soil
Dilution:	1.0	Ext Method:	Ultrasonic

UKAS accredited?: Yes

Target Compounds	CAS #	R.T. (min)	Concentration mg/kg	% Fit
Naphthalene	91-20-3	3.20	0.12	98
Acenaphthylene	208-96-8	4.24	0.09	97
Acenaphthene	83-32-9	-	< 0.08	-
Fluorene	86-73-7	-	< 0.08	-
Phenanthrene	85-01-8	5.56	0.80	99
Anthracene	120-12-7	5.61	0.22	99
Fluoranthene	206-44-0	6.88	2.01	94
Pyrene	129-00-0	7.16	1.63	94
Benzo[a]anthracene	56-55-3	8.84	1.32	96
Chrysene	218-01-9	8.89	1.51	98
Benzo[b]fluoranthene	205-99-2	10.37	2.10	94
Benzo[k]fluoranthene	207-08-9	10.41	0.73	94
Benzo[a]pyrene	50-32-8	10.79	1.05	97
Indeno[1,2,3-cd]pyrene	193-39-5	12.18	1.35	86
Dibenzo[a,h]anthracene	53-70-3	12.21	0.34	73
Benzo[g,h,i]perylene	191-24-2	12.47	1.08	80
Total (USEPA16) PAHs	-	-	< 14.51	-

"M" denotes that % fit has been manually interpreted

Internal Standards	% Area
1,4-Dichlorobenzene-d4	NA
Naphthalene-d8	86
Acenaphthene-d10	87
Phenanthrene-d10	90
Chrysene-d12	102
Perylene-d12	113

Surrogates	% Rec
Nitrobenzene-d5	NA
2-Fluorobiphenyl	107
Terphenyl-d14	90

Concentrations are reported on a wet weight basis.

The Total PAH result is the sum of non-rounded individual PAH results and therefore may differ to the sum of the rounded individual PAH results printed above. By convention, where any one or more result is a "less than", the total is expressed as a "less than" and includes the "less than" concentration within the total.

Polycyclic Aromatic Hydrocarbons GC/MS (SIM)

Customer and Site Details:	Arup: Silent Valley Waste Services		
Sample Details:	TP1 0.60	Job Number:	S15_1897
LIMS ID Number:	CL1542240	Date Booked in:	11-Mar-15
QC Batch Number:	150254	Date Extracted:	14-Mar-15
Quantitation File:	Initial Calibration	Date Analysed:	16-Mar-15
Directory:	1615PAH.GC5\	Matrix:	Soil
Dilution:	1.0	Ext Method:	Ultrasonic

UKAS accredited?: Yes

Target Compounds	CAS #	R.T. (min)	Concentration mg/kg	% Fit
Naphthalene	91-20-3	3.21	0.53	98
Acenaphthylene	208-96-8	4.24	0.14	99
Acenaphthene	83-32-9	4.36	0.12	89
Fluorene	86-73-7	4.73	0.37	94
Phenanthrene	85-01-8	5.56	1.89	96
Anthracene	120-12-7	5.61	0.50	97
Fluoranthene	206-44-0	6.88	2.42	94
Pyrene	129-00-0	7.16	1.67	67
Benzo[a]anthracene	56-55-3	8.84	1.48	91
Chrysene	218-01-9	8.89	1.27	99
Benzo[b]fluoranthene	205-99-2	10.38	1.49	76
Benzo[k]fluoranthene	207-08-9	10.41	0.49	76
Benzo[a]pyrene	50-32-8	10.73	0.93	89
Indeno[1,2,3-cd]pyrene	193-39-5	12.18	0.87	74
Dibenzo[a,h]anthracene	53-70-3	12.21	0.23	55
Benzo[g,h,i]perylene	191-24-2	12.48	0.64	88
Total (USEPA16) PAHs	-	-	15.04	-

"M" denotes that % fit has been manually interpreted

Internal Standards	% Area
1,4-Dichlorobenzene-d4	NA
Naphthalene-d8	89
Acenaphthene-d10	90
Phenanthrene-d10	91
Chrysene-d12	99
Perylene-d12	117

Surrogates	% Rec
Nitrobenzene-d5	NA
2-Fluorobiphenyl	99
Terphenyl-d14	82

Concentrations are reported on a wet weight basis.

The Total PAH result is the sum of non-rounded individual PAH results and therefore may differ to the sum of the rounded individual PAH results printed above. By convention, where any one or more result is a "less than", the total is expressed as a "less than" and includes the "less than" concentration within the total.

Petroleum Hydrocarbons (C8 to C40) by GC/FID

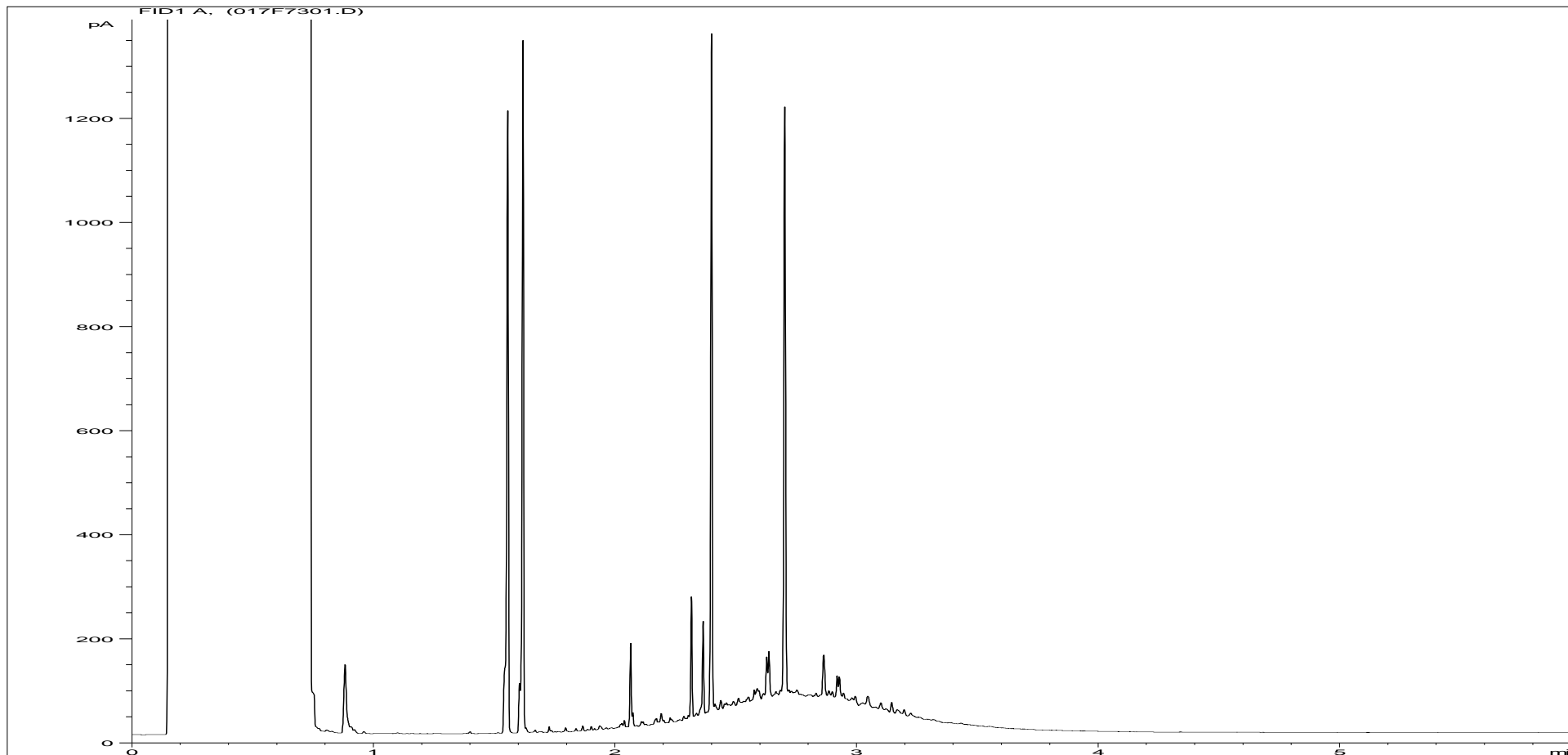

Sample ID:	CL1542235	Job Number:	S15_1897
Multiplier:	8	Client:	Arup
Dilution:	1	Site:	Silent Valley Waste Services
Acquisition Method:	5UL_RUNF.M	Client Sample Ref:	TP2 0.25
Acquisition Date/Time:	17-Mar-15, 04:25:29		
Datafile:	D:\TES\DATA\Y2015\031615TPH_GC4\031615 2015-03-16 12-10-42\017F7301.D		

Where individual results are flagged see report notes for status.

Petroleum Hydrocarbons (C8 to C40) by GC/FID

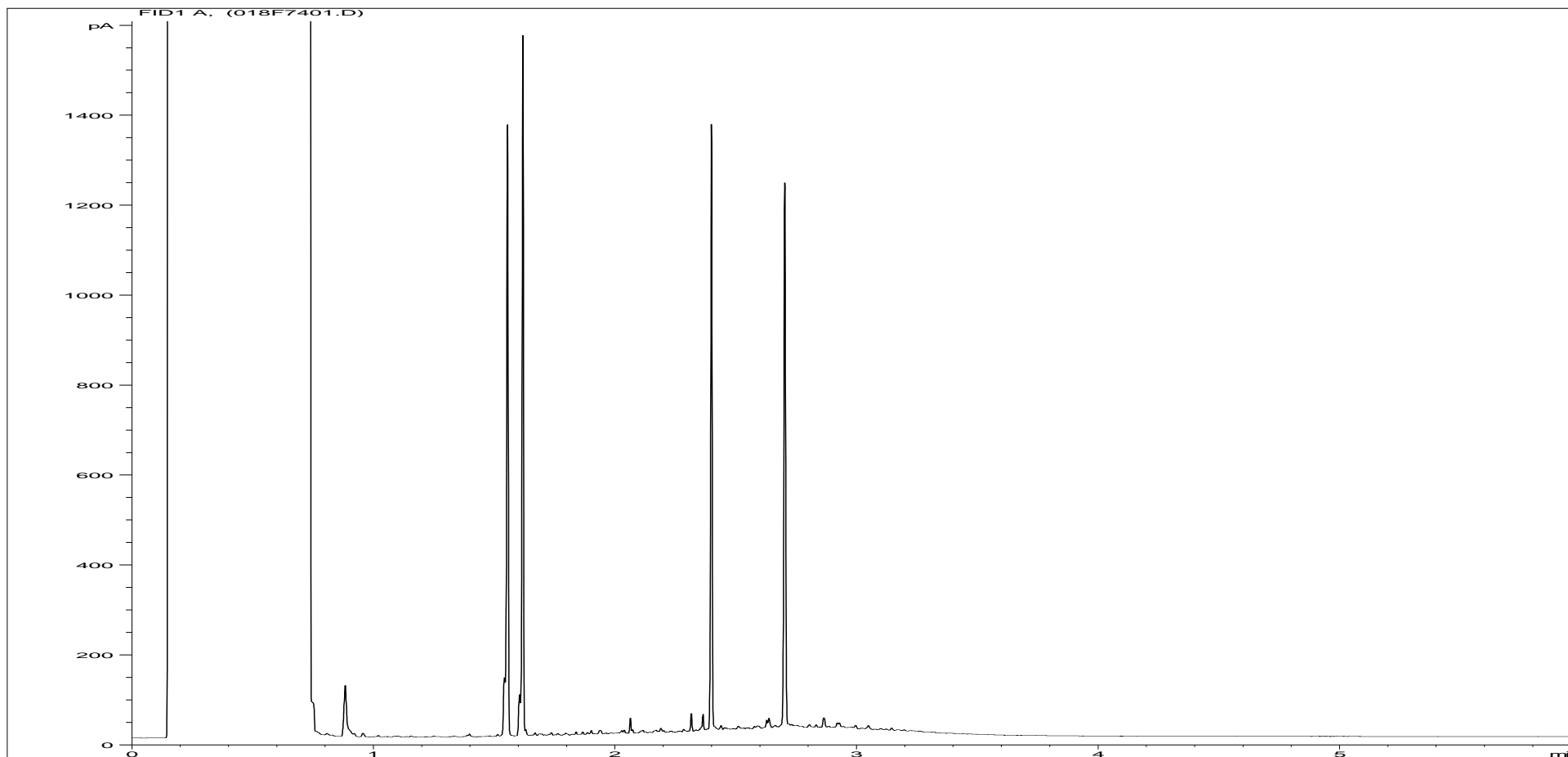

Sample ID:	CL1542236	Job Number:	S15_1897
Multiplier:	8	Client:	Arup
Dilution:	1	Site:	Silent Valley Waste Services
Acquisition Method:	5UL_RUNF.M	Client Sample Ref:	TP2 1.70
Acquisition Date/Time:	17-Mar-15, 04:38:48		
Datafile:	D:\TES\DATA\Y2015\031615TPH_GC4\031615 2015-03-16 12-10-42\018F7401.D		

Where individual results are flagged see report notes for status.

Petroleum Hydrocarbons (C8 to C40) by GC/FID

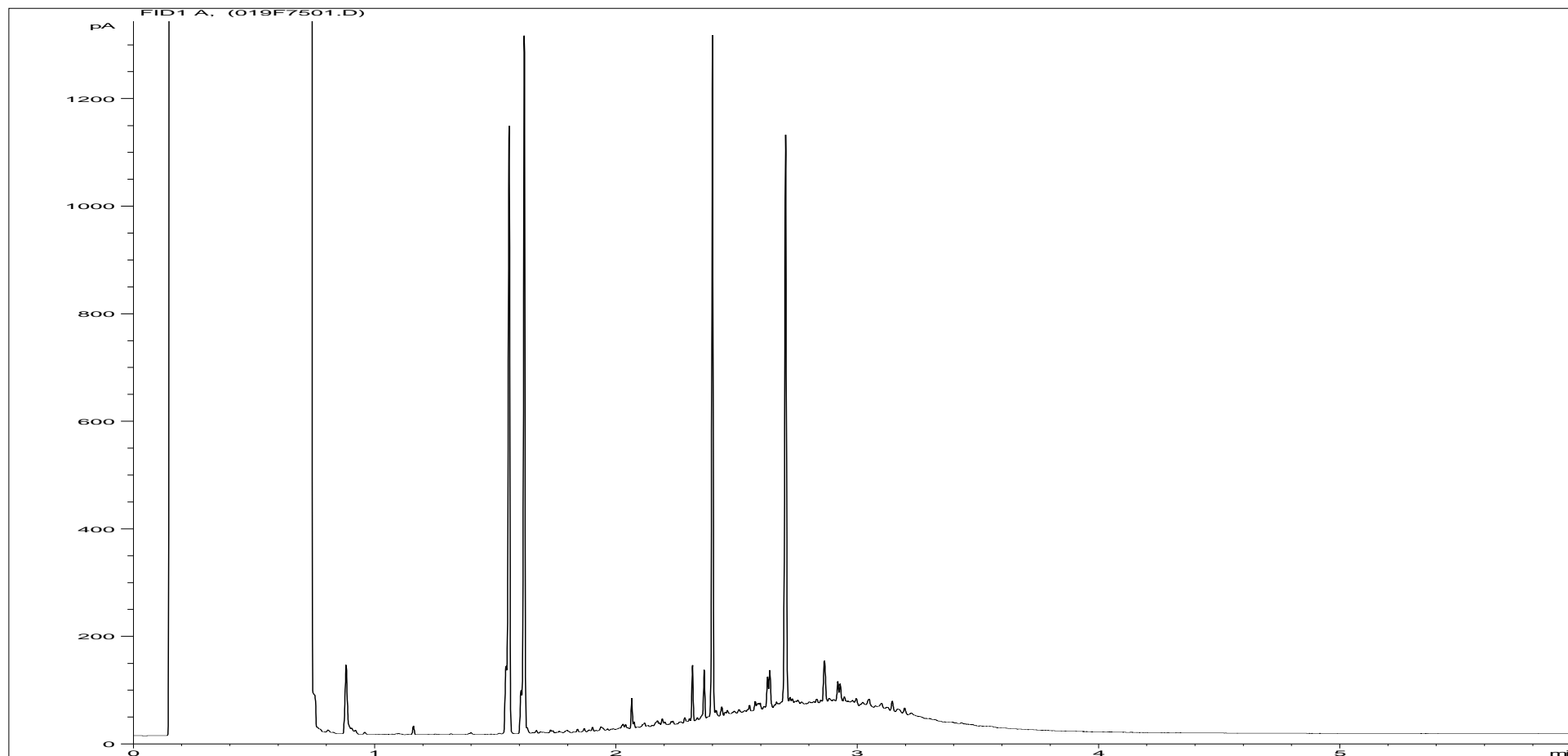

Sample ID:	CL1542237	Job Number:	S15_1897
Multiplier:	8	Client:	Arup
Dilution:	1	Site:	Silent Valley Waste Services
Acquisition Method:	5UL_RUNF.M	Client Sample Ref:	TP3 0.30
Acquisition Date/Time:	17-Mar-15, 04:52:03		
Datafile:	D:\TES\DATA\Y2015\031615TPH_GC4\031615 2015-03-16 12-10-42\019F7501.D		

Where individual results are flagged see report notes for status.

Petroleum Hydrocarbons (C8 to C40) by GC/FID

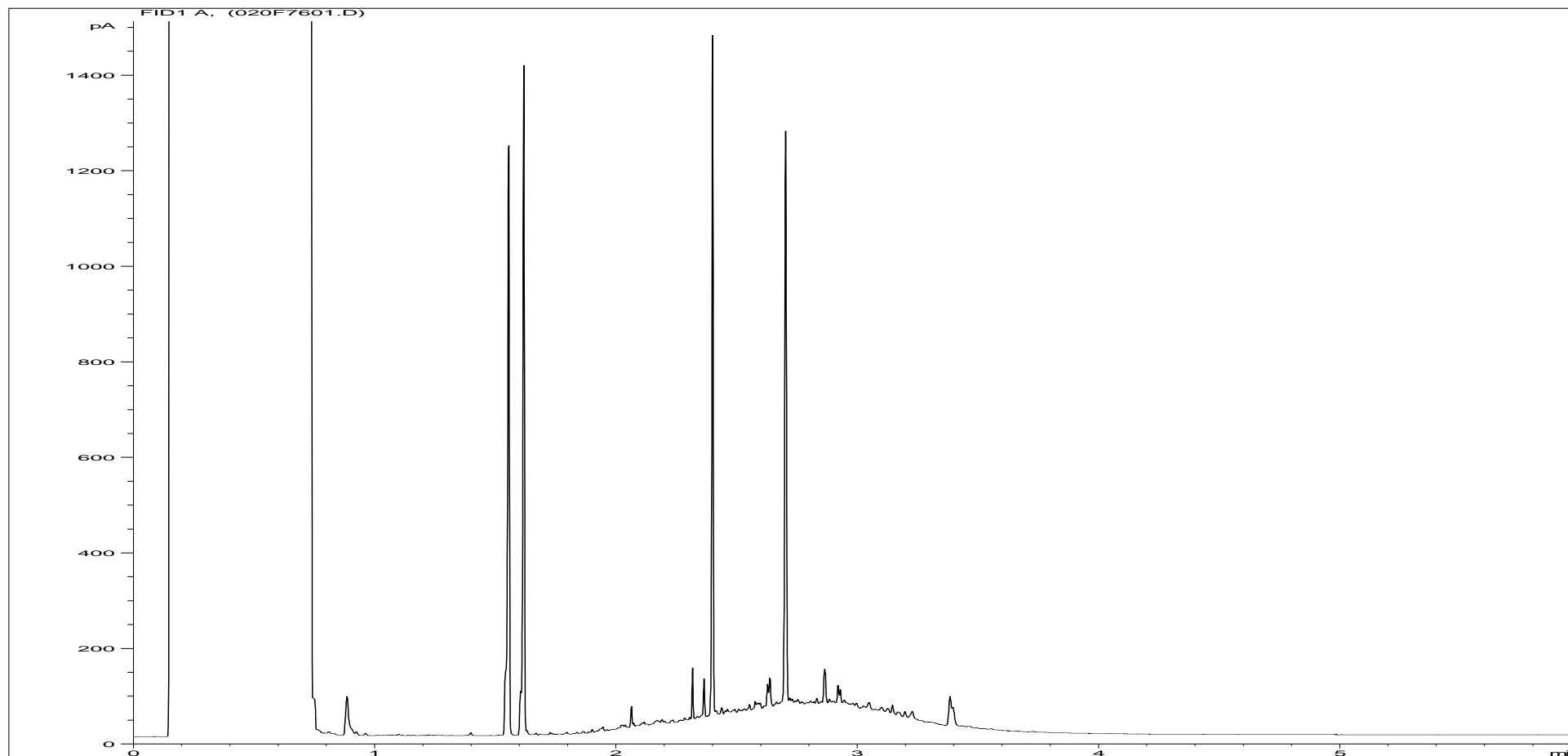

Sample ID:	CL1542238	Job Number:	S15_1897
Multiplier:	8	Client:	Arup
Dilution:	1	Site:	Silent Valley Waste Services
Acquisition Method:	5UL_RUNF.M	Client Sample Ref:	TP3 0.80
Acquisition Date/Time:	17-Mar-15, 05:05:16		
Datafile:	D:\TES\DATA\Y2015\031615TPH_GC4\031615 2015-03-16 12-10-42\020F7601.D		

Where individual results are flagged see report notes for status.

Petroleum Hydrocarbons (C8 to C40) by GC/FID

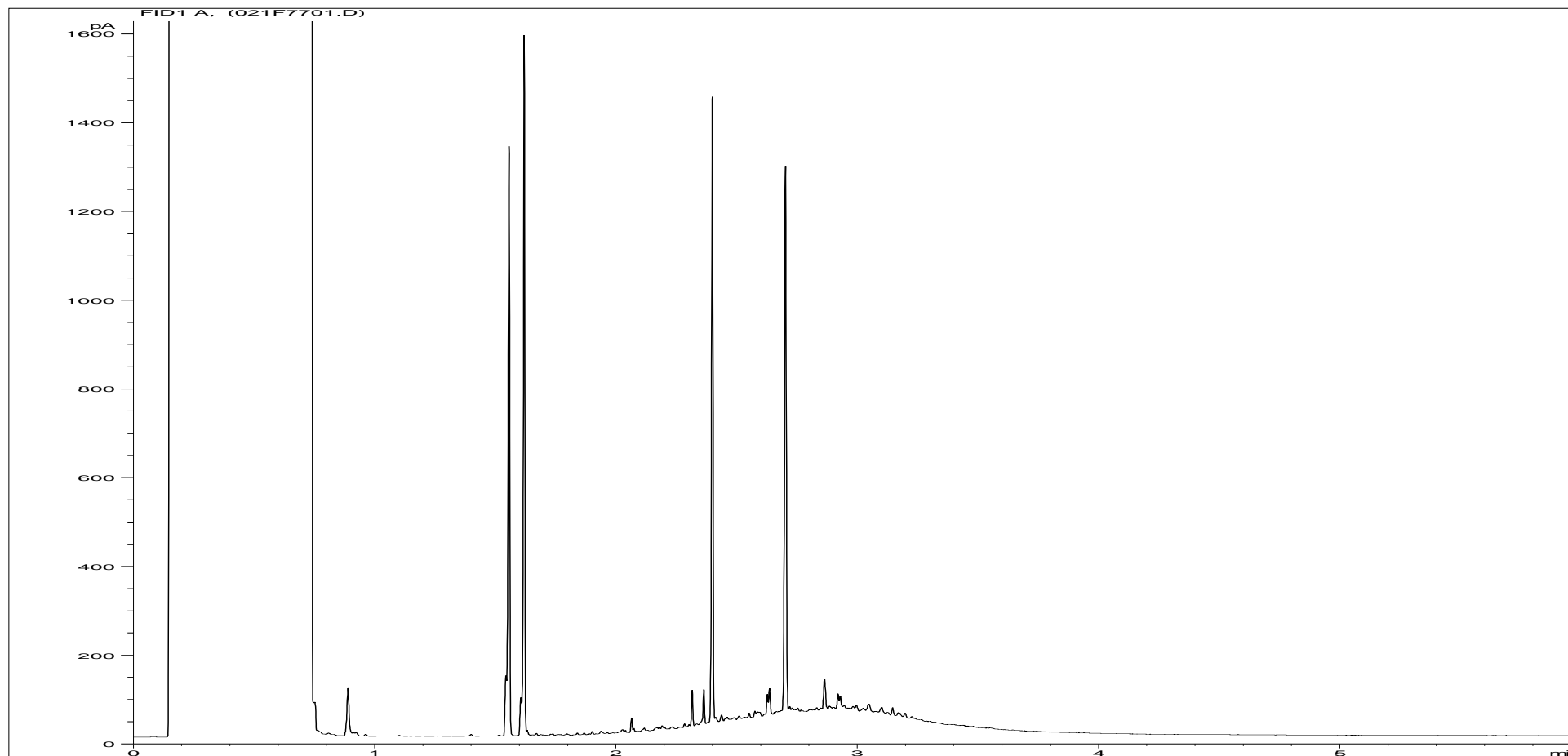

Sample ID:	CL1542239	Job Number:	S15_1897
Multiplier:	8	Client:	Arup
Dilution:	1	Site:	Silent Valley Waste Services
Acquisition Method:	5UL_RUNF.M	Client Sample Ref:	TP4 1.20
Acquisition Date/Time:	17-Mar-15, 05:18:45		
Datafile:	D:\TES\DATA\Y2015\031615TPH_GC4\031615 2015-03-16 12-10-42\021F7701.D		

Where individual results are flagged see report notes for status.

Petroleum Hydrocarbons (C8 to C40) by GC/FID

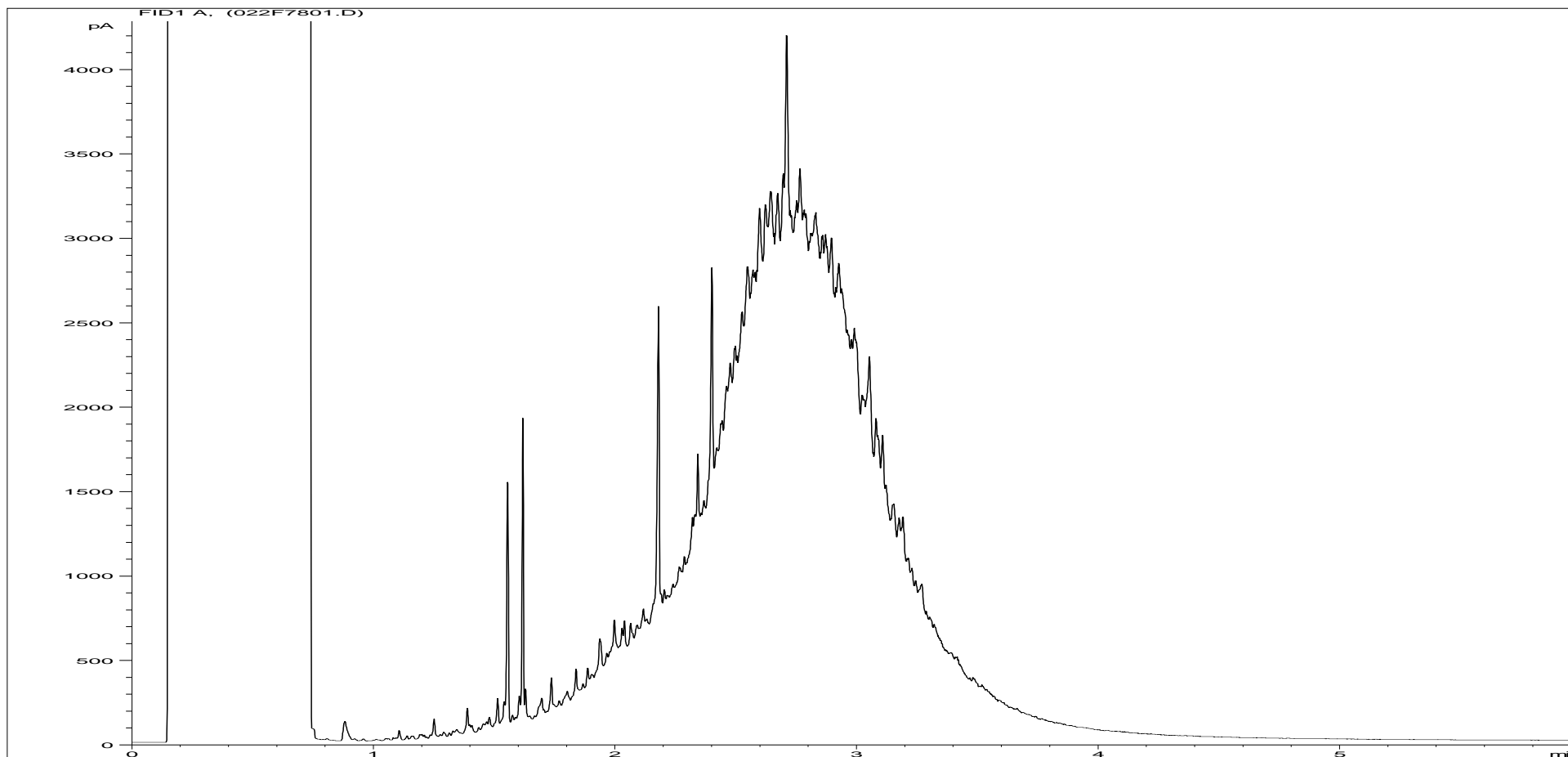

Sample ID:	CL1542240	Job Number:	S15_1897
Multiplier:	8	Client:	Arup
Dilution:	1	Site:	Silent Valley Waste Services
Acquisition Method:	5UL_RUNF.M	Client Sample Ref:	TP1 0.60
Acquisition Date/Time:	17-Mar-15, 05:32:04		
Datafile:	D:\TES\DATA\Y2015\031615TPH_GC4\031615 2015-03-16 12-10-42\022F7801.D		

Where individual results are flagged see report notes for status.

Method Descriptions

Matrix	MethodID	Analysis Basis	Method Description
Soil	ICPACIDS	Oven Dried @ < 35°C	Determination of Total Sulphate in soil samples by Hydrochloric Acid extraction followed by ICPOES detection
Soil	ICPMSS	Oven Dried @ < 35°C	Determination of Metals in soil samples by aqua regia digestion followed by ICPMS
Soil	PAHMSUS	As Received	Determination of Polycyclic Aromatic Hydrocarbons (PAH) by hexane/acetone extraction followed by GCMS detection
Soil	PHEHPLC	As Received	Determination of Phenols by methanol extraction followed by HPLC detection
Soil	PHSOIL	As Received	Determination of pH of 2.5:1 deionised water to soil extracts using pH probe.
Soil	SFAPI	As Received	Segmented flow analysis with colorimetric detection
Soil	SFAS	As Received	Segmented flow analysis with colorimetric detection
Soil	SubCon*	*	Contact Laboratory for details of the methodology used by the sub-contractor.
Soil	TPHFIDUS	As Received	Determination of hexane/acetone extractable Hydrocarbons in soil with GCFID detection.

Where individual results are flagged see report notes for status.

Report Notes

Generic Notes

Soil/Solid Analysis

Unless stated otherwise,

- Results expressed as mg/kg have been calculated on the basis indicated in the Method Description table.
All results on MCERTS reports are reported on a 105°C dry weight basis with the exception of pH and conductivity.
- Sulphate analysis not conducted in accordance with BS1377
- Water Soluble Sulphate is on a 2:1 water:soil extract

Waters Analysis

Unless stated otherwise results are expressed as mg/l

Nil: Where "Nil" has been entered against Total Alkalinity or Total Acidity this indicates that a measurement was not required due to the inherent pH of the sample.

Oil analysis specific

Unless stated otherwise,

- Results are expressed as mg/kg
- SG is expressed as g/cm³@ 15°C

Gas (Tedlar bag) Analysis

Unless stated otherwise, results are expressed as ug/l

Asbestos Analysis

CH Denotes Chrysotile

TR Denotes Tremolite

CR Denotes Crocidolite

AC Denotes Actinolite

AM Denotes Amosite

AN Denotes Anthophyllite

NAIIS No Asbestos Identified in Sample

NADIS No Asbestos Detected In Sample

Symbol Reference

^ Sub-contracted analysis.

\$\$ Unable to analyse due to the nature of the sample

¶ Samples submitted for this analyte were not preserved on site in accordance with laboratory protocols.

This may have resulted in deterioration of the sample(s) during transit to the laboratory.

Consequently the reported data may not represent the concentration of the target analyte present in the sample at the time of sampling

¥ Results for guidance only due to possible interference

& Blank corrected result

I.S Insufficient sample to complete requested analysis

I.S(g) Insufficient sample to re-analyse, results for guidance only

Intf Unable to analyse due to interferences

N.D Not determined

N.Det Not detected

N.F No Flow

NS Information Not Supplied

Req Analysis requested, see attached sheets for results

P Raised detection limit due to nature of the sample

* All accreditation has been removed by the laboratory for this result

‡ MCERTS accreditation has been removed for this result

§ accreditation has been removed for this result as it is a non-accredited matrix

Note: The Laboratory may only claim that data is accredited when all of the requirements of our Quality System have been met. Where these requirements have not been met the laboratory may elect to include the data in its final report and remove the accreditation from individual data items if it believes that the validity of the data has not been affected. If further details are required of the circumstances which have led to the removal of accreditation then please do not hesitate to contact the laboratory.

Appendix C

Slag testing results and recommendations (Thomas Research Services Ltd)

TRS Report

Report Ref: DF5C01-06/EBV/ARU/IDT/TRS/03/15/RP1
Date Issued: 26 March 2015
TRS Sample Refs: DF5C01-06
Order No: SVPO/5783

**PETROLOGICAL EXAMINATION OF 6 BULK SAMPLES
FROM EBBW VALE (NP36 6PZ)
FOR ARUP**



Thomas Research Services Ltd.

Tel: +44 (0) 1469 532 929

www.slagtest.co.uk

Unit 7, Tattershall Castle Court, Morgan Way, New Holland,
North Lincolnshire, DN19 7PZ, United Kingdom

A Limited Company registered in England. Company Registration No: 2518421

PETROLOGICAL EXAMINATION OF 6 BULK SAMPLES FROM EBBW VALE (NP36 6PZ) FOR ARUP

1. BACKGROUND

Six bulk samples were received from the site on 16th March 2015. TRS understands the site to be around 15,000 square metres in size, and that the fill is between 0.5 and 4.5+ metres.

Each sample was weighed and allocated a unique TRS reference, the details of which are recorded below:-

TRS Ref	Site Ref	Depth/m	Mass/kg
DF5C01	TP1	0.7	11.5
DF5C02	TP1	1.2	11.6
DF5C03	TP2	0.5	13.0
DF5C04	TP2	1.5	13.6
DF5C05	TP3	0.7	10.5
DF5C06	TP4	0.7	11.4

The purpose of the exercise was to identify any products from iron and steel making operations, and to assess whether there was any risk of potential for volumetric instability from these materials.

2. SAMPLE PREPARATION & PROGRAMME OF ANALYSIS

The six samples were primary crushed to reduce particle size down to <50mm, portions then being selected and dried at low temperature to constant weight. The dried material was subjected to a regime of stage crushing and quartering to further reduce particle size down to <5mm. Portions of this <5mm material were made up into resin bound blocks, one face of which was ground flat and polished using diamond pastes. Further portions of the <5mm material were

milled to a fine powder. Portions were extracted throughout the preparation procedure to provide the necessary test specimens for any tests and analyses that may subsequently need to be carried out.

A petrological examination was made of the polished blocks using reflected light microscopy, the complete findings of which are recorded in appendix A.

3. DISCUSSION OF RESULTS

A petrological examination was made of the six samples using reflected light microscopy. The complete findings of this examination are recorded in appendix A.

The samples examined consisted mainly of blast furnace slag and basic steel slag. A minor amount of basic refractory material was seen in one of the samples. Other constituents were identified in the samples in varying but often minor amounts. These included alumino-silicate refractory, acid steel slag, quartz, sandstone, dolomitic limestone, shale, metallic iron, rust, fume, coal, coke and used Portland cement. A cementitious material often bonded the finer particles together and was similar to the slag alteration products, but may also contain some clay.

The blast furnace slag was seen in all six samples, in medium amounts in four of the samples and in large amounts in the remaining two. The slag was predominantly crystalline, but minor amounts of glassy and ceramic material were seen in some samples. The mineralogy of the crystalline slag was dominated by melilite, along with more minor amounts of merwinite, dicalcium silicate, wollastonite, calcium silicate, calcium sulphide and metallic iron. The slag was significantly altered due to weathering, with substantial calcite seen and a little well crystallised gypsum. Old weathered blast furnace slag may contain

pockets of potentially expansive material (see appendix B). This potential for expansion can only be assessed with direct expansion testing.

Basic steel slag was also seen in all six samples; in medium amounts in three samples and small amounts in the remaining three. The slag showed a wide range of composition, varying from particle to particle. The dominant phases were dicalcium silicate and RO phase, along with more minor amounts of tricalcium silicate, R_3O_4 & CaF phases, lime phase and periclase. The mineralogy would suggest that the material is likely to have significant potential for expansion. This potential can only be assessed with direct expansion testing.

The minor amount of basic refractory material was seen in sample DF5C02 (TP1 – 1.2m). This consisted mainly of partly hydrated periclase and is likely to have significant potential for expansion.

4. CONCLUSIONS & RECOMMENDATIONS

The following conclusions can be drawn:-

- The samples comprised predominantly of blast furnace slag and basic steel slag. A minor amount of basic refractory material was also seen in one of the samples.
- The blast furnace slag was significantly altered from weathering. Old weathered blast furnace slag may contain pockets of potentially expansive material. This potential can only be assessed with direct expansion testing.
- The basic steel slag and basic refractory material are likely to have significant potential for expansion. As with the blast furnace slag, this potential can only be assessed with direct expansion testing.
- Various other products were seen in the samples in varying amounts. These included alumino-silicate refractory, acid steel slag, quartz, sandstone, dolomitic limestone, shale, metallic iron, rust, fume, coal, coke and used Portland cement.

The following recommendations are made:-

The actual potential for expansion in the samples can only be assessed by direct expansion testing. All six samples should therefore be subjected to the following tests and analyses:-

- TRS accelerated expansion test (28 day duration)
- Water & acid soluble sulphates
- Total sulphur
- Free CaO & free MgO
- Thermal analysis (DTA & TGA)

If the site is to be developed, then procedures should be in place to assess the types and amounts of iron and steel industry present, and to assess the slag for expansive potential. TRS would recommend that the fill is sampled at one sample per 600 cubic metres, and that petrological examination be made of those samples. Samples found to contain significant slag should be subjected to expansion testing.

Note

These conclusions apply only to the samples tested and may not represent the bulk of the material on the site from which they were taken.

Ian D. Thomas

Ian D Thomas BSc(Hons)
Thomas Research Services Ltd

26 March 2015

APPENDIX A

PETROLOGICAL REPORT ON SAMPLES DF5C 01-06

A petrological examination has been carried out of six samples, DF5C 01 to 06.

Polished blocks were prepared using particulate material crushed to a nominal size of ~ 5 mm. Representative material was made up into resin-bonded blocks. One face of each of these was ground flat and polished using diamond pastes. In addition, when appropriate, the surfaces were selectively etched with water, 10% MgSO_4 solution and 0.1%N HCl in order to help with the phase identification.

The detailed results are given in the accompanying Table.

All the samples consist mainly of blast furnace and basic steel slag. Blast furnace slag is present in medium to large amounts and basic steel slag in small or medium amounts. A very small amount of magnesia-rich basic refractory material was seen in sample 02.

The blast furnace slag shows little variation from sample to sample. It is mainly crystalline with melilite (Ca,Mg,Al silicate) as the principal phase. A little merwinite (Ca,Mg silicate) and dicalcium silicate (e.g. larnite ($\beta\text{-Ca}_2\text{SiO}_4$) and, possibly, bredigite (Ca_2SiO_4 with some Mg in solid solution)) has been identified in most samples. These together with some other silicates such as wollastonite (Ca silicate) and titanium-bearing Ca silicate occur as a matrix to the melilite crystals. A little calcium sulphide is present. It occurs as finely disseminated, dendritic grains. There are also minor amounts of metallic iron, forming minute spherules. There is some glassy slag and finely crystalline ceramic slag. Secondary alteration is substantial. There is much calcite (CaCO_3) but only a little well-crystallised gypsum ($\text{CaSO}_4 \cdot 2\text{H}_2\text{O}$) was seen. Most of the alteration products are difficult to identify specifically under the microscope and are likely to be silicate and sulpho-aluminate hydrates such as ettringite.

The basic steel slag shows a wide range in composition from particle to particle within the individual samples. It consists mainly of dicalcium silicate together with some tricalcium silicate. RO and R_3O_4 phases (FeO and Fe_3O_4 with some Al, Mn, Mg and Ca in solid solution) and CaF phases (complex Ca alumino-ferrites) are present. Lime phase (CaO with some Fe, Mn and Mg in solid solution) is present in small or very small amounts. The lime phase occurs (a) interstitially to the other phases, (b) is granular resulting from exsolution during cooling of the tricalcium silicate, and (c) as spongy grains up to about 0.1mm in size. Periclase (MgO with some Fe in solid solution) is also present in small or very small amounts and is typically more common than the lime phase. It typically occurs as

granular crystals up to about 0.2mm in size that are encapsulated by more Fe-rich RO phase. The slag alteration products are, again, mostly difficult to identify specifically but are probably mainly hydrated silicates as well as calcite.

The basic refractory material is magnesian consisting mainly of partly hydrated periclase (MgO).

Other constituents include aluminosilicate refractory material, acid (silicic) steel slag, quartz, sandstone, dolomitic limestone, shale, metallic iron, rust, fume, coal, coke and used Portland cement. There are small to medium amounts of cementitious material binding the smaller and adherent to the larger particles. This appears to be similar to the slag alteration products but probably also include some clay.

TRS SAMPLES DF5C 01-06

	1	2	3	4	5	6
BLAST FURNACE SLAG						
Amount	<i>m</i>	<i>m</i>	<i>m</i>	<i>l</i>	<i>m</i>	<i>l</i>
Phases present:-						
Melilite	l	l	l	l	l	l
Merwinite	s	s	-	vs	vs	vs
Larnite & bredigite	vs	vs	vs	vs	vs	vs
Matrix & other silicates	s	s	s	s	s	s
Ca & Fe,Mn sulphides	vs	vs	vs	vs	vs	vs
Metal, rust, scale etc.	vs	vs	vs	vs	vs	vs
Glassy slag	-	-	-	s	-	-
Ceramic slag	-	-	s	-	s	-
Alteration products	m	m	m	m	m	m
Calcite	m	m	s	m	m	s
Gypsum	-	-	-	-	-	s
BASIC STEEL SLAG						
Amount	<i>m</i>	<i>m</i>	<i>s</i>	<i>s</i>	<i>m</i>	<i>s</i>
Phases present:-						
Dicalcium silicate	l	l	l	l	l	m
Tricalcium silicate	s	-	-	-	-	-
RO phase	m	m	m	m	m	m
CaF phase	s	s	s	s	s	s
R3O4 phase	s	s	s	s	s	s
Metal & rust	s	vs	vs	-	vs	vs
Lime phase	vs	vs	s	vs	s	vs
Periclase	s	s	s	vs	vs	vs
Alteration products	m	m	m	m	m	l
BASIC REFRACTORIES						
Amount	-	vs	-	-	-	-
OTHER CONSTITUENTS						
Alumino-silicate brick	s	s	s	s	s	s
Quartz, sandstone, etc.	s	m	l	m	m	m
Acid steel slag	-	-	s	-	-	-
Cindery slag	vs	-	-	-	-	-
Metal, rust, scale & fume	s	s	s	s	s	s
Limestone & dolomite	s	-	-	s	m	s
Shale, clay & ash	vs	vs	s	s	s	s
Coke	s	s	s	s	s	s
Coal & char	vs	vs	vs	vs	vs	vs
Cementitious material & clay	s	s	m	m	m	s
Used Portland cement	-	-	-	vs	vs	-

L = very large, l = large, m = medium, s = small and vs = very small amounts

GENERAL EXPLANATION

L = very large, l = large, m = medium, s = small and vs = very small amounts.

Blast furnace slag. When present this consists mainly of melilite (Ca,Mg,Al silicate ranging in composition between $\text{Ca}_2\text{Al}_2\text{SiO}_7$ and $\text{Ca}_2\text{MgSi}_2\text{O}_7$). Other common phases are merwinite ($\text{Ca}_3\text{MgSi}_2\text{O}_8$), larnite ($\beta\text{-Ca}_2\text{SiO}_4$) and bredigite (Ca_2SiO_4 with some Mg in solid solution). The matrix often consists of some of the above phases, especially melilite, but may also contain other phases such as wollastonite (CaSiO_3), anorthite ($\text{CaAl}_2\text{Si}_2\text{O}_8$) and pyroxene ($(\text{CaMg})\text{SiO}_3$). Spinel (MgAl_2O_4) may be present. Sulphides and metal usually occur and are mostly finely dispersed, but the metal sometimes occurs as prills and may contain some graphite and Ti carbo-nitride (TiCN). Material reported as ceramic in appearance is very finely crystalline. The alteration products often include calcite and gypsum but are mostly silicate and/or sulpho-aluminate hydrates that are difficult to identify specifically under the microscope.

Basic steel slag. When present this consists mainly of dicalcium silicate, mostly the β -form (larnite) but sometimes the alpha form. Phosphoric slags may contain nagelschmidtite (Ca_2SiO_4 with $\text{Ca}_3\text{P}_2\text{O}_8$ in solid solution). Other silicate often present in small amounts, unetched by dilute HCl, is probably melilite. RO, R_3O_4 and RF phases are typically present and are mainly FeO and Fe_3O_4 with some Mg, Mn, Ca, etc. in solid solution and complex Ca alumino-ferrites. There may also be some Fe_2O_3 and spinel ($(\text{Mg,Fe})\text{Al}_2\text{O}_4$). The slag typically carries minor amounts of periclase (MgO with some Fe in solid solution) and lime phase (CaO with some Fe, Mn & Mg in solid solution). Other possible minor constituents include fluorite (CaF_2) and apatite (Ca fluoro-phosphate), the last present in phosphoric slags. The alteration products are, again, difficult to identify specifically but are probably, mainly, hydrated silicates. Portlandite ($\text{Ca}(\text{OH})_2$) may be present.

Basic refractory material. When present, this is mainly magnesian and consists of granular periclase (MgO) with interstitial silicates. Sometimes samples contain chrome-magnesia material with chromite present in addition to the other phases. Hot face material (from close to the furnace) may also occur. The periclase and interstitial silicates show secondary alteration similar to that of the basic steel slag. Brucite ($\text{Mg}(\text{OH})_2$) is likely.

Acid steel slag. When present this consists mainly of fayalite ($(\text{Fe,Mn})_2\text{SiO}_4$), Fe,Mn oxides and cristobalite (high temperature SiO_2).

Other slags. The 'intermediate slag' (probably primary flush slags from steel furnaces) has a variable phase assemblage, being mainly formed of silicates, particularly dicalcium silicate, melilite, merwinite and a complex olivine phase together with spinel and wustite (FeO). Sometimes it contains significant amounts of periclase, well embedded in the slag. The 'ferrous slag' (probably from foundry operations) has similar silicates but much more substantial content of iron oxides, usually wustite. It is often associated with scale (iron oxides formed on the surface of steel during reheating/cooling). When present, the 'cindery slag' consists of various silicates and silicate glass with Fe oxides, hercynite (FeAl_2O_4) and, sometimes, corundum (Al_2O_3). It is usually derived from heating furnaces and is often associated with burnt shale. When present, the 'siliceous clinker' is similar but devoid of iron oxides.

Other constituents The alumino-silicate brick includes a range of refractory firebrick, common brick and alumina-rich refractories. The 'quartz, sandstone, etc.' may include used silica refractory material consisting of quartz and its high temperature forms. Sometimes there is a distinct granular texture and it is derived from silcrete, a kind of chert. Cementitious material may bond the finer particles together. It is similar to the other alteration products consisting mostly of complex hydrates difficult to identify under the microscope. Sometimes some is used Portland cement recognised by the relict textures of the clinker and the embedded quartz sand.

APPENDIX B

MECHANISMS OF VOLUMETRIC INSTABILITY IN IRON AND STEEL INDUSTRY SLAGS

Volumetric change with time can occur in some types of iron and steel industry slags. These mechanisms are briefly described in this section.

Blast Furnace Slags

Fresh-make air-cooled, i.e. crystalline, blast furnace slags are almost always volumetrically stable after cooling. The two mechanisms for volumetric instability listed in BS1047:1983 – “Air Cooled Blast furnace Slag for use in Construction” are:-

- a) Beta to gamma inversion of dicalcium silicate.**
- b) Iron unsoundness.**

a) Research by G H Thomas on this phase transformation has shown the transformation to be athermal rather than isothermal. In practical terms this means that inversion, and the expansion associated with it, can only occur during the cooling cycle. In fully cooled material there would appear to be no further risk of instability from this mechanism.

b) Iron unsoundness is a very rare form of instability frequently associated with operating problems in the blast furnace. TRS know of only one instance in over 40 years. The mechanism, which is a hydrolysis reaction, is immediately triggered off by the presence of water. Once water has initiated the reaction, the mechanism proceeds to completion. It is impossible to arrest the process once started; at least by methods operating in normal ambient conditions.

It follows that the risk of late expansion from either of these mechanisms in blast furnace slag is remote.

c) Sulphoaluminate Type Activity

Some years ago, G. H. Thomas discovered a third mechanism that may give rise to volumetric instability. The process is possible only in some old blast furnace slag altered by weathering. When the sulphide sulphur in the blast furnace slags is oxidised during weathering to sulphate, under some circumstances reactions can take place within the slag to produce an 'ettringite' type product. The process is somewhat analogous to sulphatic attack on concrete and has a similar result - expansion of the mass and associated disruption.

For the mechanism to have any significance, the slag needs to have residual potential for this reaction. Evidence of past activity does not necessarily indicate further reaction is possible.

The TRS accelerated expansion test is, we believe, uniquely capable of identifying such slags, as well as instability attributable to free CaO and free MgO in steel slag & etc.

Basic Steel Slags

Basic steel slags commonly contain significant quantities of free CaO and free MgO. These free oxides are well known for the massive expansion associated with their hydration. In practical terms, it is impossible to forecast when hydration will take place, but it can be up to decades after the material was cooled – or placed. The reasons are complex, but include the varying density of the oxides, due to the variation in temperatures at which the products have been held in the furnace. Other factors influencing rate of hydration include:-

- the protection of slags by a reaction product at the oxide interface with the slag.

- the presence of the oxides as lime or magnesia rich solid solutions instead of the pure oxide.

The result is potential future volumetric instability but at an unforeseeable date. Periclase, i.e. free MgO, is relatively much slower than free CaO to hydrate.

Scrap High Magnesia Refractories

These are particularly undesirable components in fill as they commonly result in high concentrations of free MgO. The problems associated with these concentrations are similar to those where periclase is found in basic steel slag.

Figures

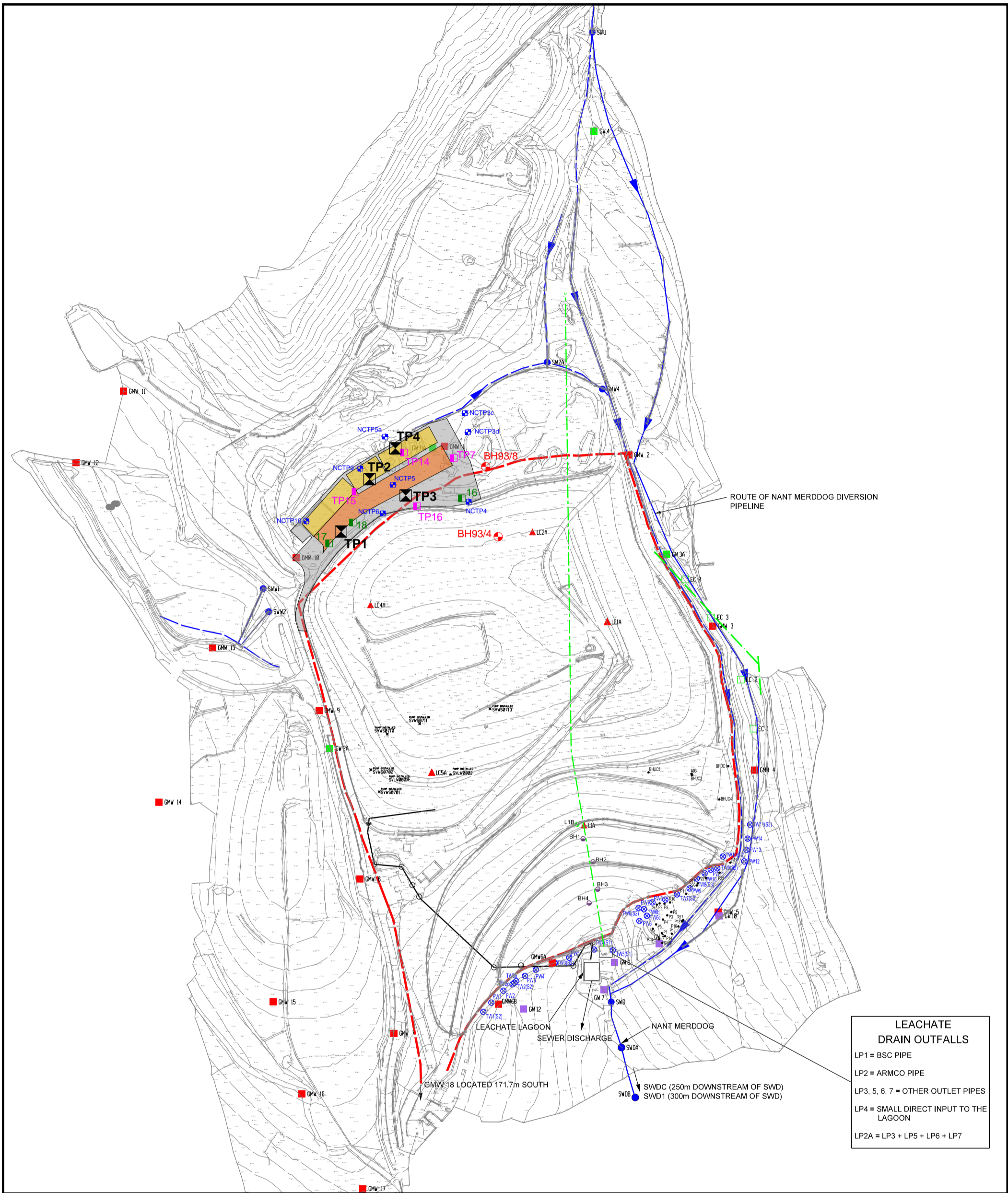

LEACHATE DRAIN OUTFALLS
 LP1 = BSC PIPE
 LP2 = ARMCO PIPE
 LP3, 5, 6, 7 = OTHER OUTLET PIPES
 LP4 = SMALL DIRECT INPUT TO THE LAGOON
 LP2A = LP3 + LP5 + LP6 + LP7

LEGEND

- | | | | | |
|--|------|-------------------------------------|--|--|
| | EC 1 | EASTERN CUT-OFF MONITORING WELLS | | REINFORCED CONCRETE SLAB UNDER CANOPY LOCATION |
| | GMW5 | GAS MONITORING POINTS | | OPEN AIR CONCRETE SLAB LOCATION |
| | GW10 | COMPLAINEE POINT GROUND WATER WELLS | | WASTE TRANSFER STATION LOCATION AND LAYOUT |
| | GW4 | GROUND WATER MONITORING WELLS | | HISTORICAL TRIAL PITS (Nov. 2012) |
| | SW1 | SURFACE WATER SAMPLING POINTS | | HISTORICAL TRIAL PITS (Feb. 1993) |
| | LC1 | LEACHATE MONITORING WELLS | | HISTORICAL TRIAL PITS (Feb. 1996) |
| | | SURFACE WATER DITCHES | | HISTORICAL TRIAL PITS (Dec. 1993) |
| | | EXTENT OF LANDFILLED WASTE | | 'AS-BUILT' TRIAL PIT LOCATIONS |
| | | PUMPING WELL CUT OFF SYSTEM | | |

Silent Valley
 GENERAL SITE LAYOUT
 115825-00
 FIGURE 1