



**APPLICATION FOR AN ENVIRONMENTAL PERMIT  
VARIATION UNDER THE ENVIRONMENTAL  
PERMITTING (ENGLAND AND WALES)  
REGULATIONS 2016 (AS AMENDED)**

**ENVIRONMENTAL PERMITTING TECHNICAL  
REQUIREMENTS DOCUMENT**



**ABRIL INDUSTRIAL WAXES LIMITED,  
STURMI WAY, VILLAGE FARM INDUSTRIAL  
ESTATE, PYLE, BRIDGEND, CF33 6BZ**

**ECL Ref: AIWL.01.01/EPTR  
June 2025  
Version: Issue 3**

## TABLE OF CONTENTS

<b>1. INTRODUCTION</b>	<b>1</b>
1.1. Overview	1
1.2. Installation Location	1
1.3. The Applicant	2
1.4. Pre-Application Advice	2
<b>2. LISTED ACTIVITIES</b>	<b>3</b>
2.1. Current Activities	3
2.2. Proposed Activities	3
<b>3. MANAGEMENT TECHNIQUES</b>	<b>5</b>
3.1. Overview of Environmental Management System	5
3.2. Amendments to the Environmental Management System	5
<b>4. OPERATING TECHNIQUES</b>	<b>6</b>
4.1. Technical Standards	6
4.2. Current Activities	6
4.3. Proposed Activities	7
<b>5. EMISSIONS</b>	<b>8</b>
5.1. Point Source Emissions to Air – Current Arrangements	8
5.2. Point Source Emissions to Air – Proposed Arrangements	8
5.3. Point Source Emissions to Surface Water – Current Arrangements	8
5.4. Point Source Emissions to Surface Water – Proposed Arrangements	8
5.5. Point Source Emissions to Sewer – Current Arrangements	8
5.6. Point Source Emissions to Sewer – Proposed Arrangements	9
5.7. Point Source Emissions to Land – Current Arrangements	9
5.8. Point Source Emissions to Land – Proposed Arrangements	9
5.9. Fugitive Emissions to Air	9
5.10. Fugitive Emissions to Surface Water, Sewer and Groundwater	9
5.11. Bund Specification	10
<b>6. GENERAL REQUIREMENTS</b>	<b>11</b>
6.1. Emissions Management	11
6.2. Odour Management	11
6.3. Noise Management	11
6.4. Pest Management	11
6.5. Fire Management	12
<b>7. MONITORING</b>	<b>13</b>
7.1. Monitoring of Emissions to Air – Current Arrangements	13
7.2. Monitoring of Emissions to Air – Proposed Arrangements	13
7.3. Monitoring of Groundwater and Soil	13
7.4. Monitoring of Surface Water – Current Arrangements	13
7.5. Monitoring of Surface Water – Proposed Arrangements	14
7.6. Monitoring of Foul Water – Current Arrangements	14
7.7. Monitoring of Foul Water – Proposed Arrangements	15
<b>8. RESOURCE EFFICIENCY AND CLIMATE CHANGE</b>	<b>16</b>
8.1. Energy Efficiency Measures	16
8.2. Energy Consumption	16
8.3. Climate Change Agreement	17
8.4. Raw Material Justification and Waste Minimisation	17
<b>9. COMPLIANCE WITH BAT CONCLUSIONS</b>	<b>19</b>
9.1. Overview	19

## LIST OF TABLES

<b>Table 1: Schedule 1 Activities</b>	<b>3</b>
<b>Table 2: S1 Monitoring Requirements</b>	<b>14</b>
<b>Table 3: S1 Emissions Limits and Monitoring Frequency to Sewer</b>	<b>14</b>
<b>Table 4: Energy Consumption</b>	<b>16</b>
<b>Table 5: Large Volume Organic Chemicals BREF - General BAT Conclusions</b>	<b>20</b>

## LIST OF APPENDICES

<b>Appendix I</b>	<b>Process Flow Diagram</b>
<b>Appendix II</b>	<b>Pre-Application Advice</b>
<b>Appendix III</b>	<b>Baxxodur 280 Safety Data Sheet</b>
<b>Appendix IV</b>	<b>ISO 14001 Certificate</b>
<b>Appendix V</b>	<b>Trade Effluent Consent &amp; Correspondence</b>
<b>Appendix VI</b>	<b>Spillage Procedure</b>
<b>Appendix VII</b>	<b>Incident Report Form</b>

## ACRONYMS / TERMS USED IN THIS REPORT

<b>Abril</b>	<b>Abril Industrial Waxes Limited</b>
<b>BAT</b>	<b>Best Available Techniques</b>
<b>BREF</b>	<b>Best Available Techniques Reference Document</b>
<b>CCA</b>	<b>Climate Change Agreement</b>
<b>CO<sub>2</sub></b>	<b>Carbon Dioxide</b>
<b>EA</b>	<b>Environment Agency</b>
<b>ECL</b>	<b>Environmental Compliance Limited</b>
<b>EMS</b>	<b>Environmental Management System</b>
<b>EP Regulations</b>	<b>Environmental Permitting (England and Wales) Regulations 2016 as amended</b>
<b>EPTR</b>	<b>Environmental Permitting Technical Requirements Document</b>
<b>ERA</b>	<b>Environmental Risk Assessment</b>
<b>IED</b>	<b>Industrial Emissions Directive</b>
<b>LED</b>	<b>Light-emitting Diode</b>
<b>LEV</b>	<b>Local Exhaust Ventilation</b>
<b>LII</b>	<b>Low Impact Installation</b>
<b>New Diamine</b>	<b>3,3'-(butane-1,4-diylbis(oxy))bispropaneamine (Baxxodur EC 280, or similar)</b>
<b>NGR</b>	<b>National Grid Reference</b>
<b>NRW</b>	<b>Natural Resources Wales</b>
<b>SDS</b>	<b>Safety Data Sheet</b>
<b>The Installation</b>	<b>Area contained within the Environmental Permit boundary at Abril Industrial Waxes Limited</b>
<b>VOC</b>	<b>Volatile Organic Compounds</b>

## 1. INTRODUCTION

### 1.1. Overview

- 1.1.1. Environmental Compliance Limited (“ECL”) has been commissioned by Abril Industrial Waxes Limited (“Abril”) to prepare an Environmental Permitting Technical Requirements (“EPTR”) document to form part of the Environmental Permit (“EP”) variation application at their site located at Sturmi Way, Village Farm Industrial Estate, Pyle, Bridgend, CF33 6BZ (hereafter referred to as “the Installation”).
- 1.1.2. Abril are producers of industrial waxes. These waxes, which are predominantly amide waxes, are made from a reaction of an amine with an acid. Hydrogen and oxygen released during the reaction combine to form water. The heat raised during the reaction converts the water to steam which is subsequently cooled in the condensers and the water is then discharged as effluent.
- 1.1.3. The raw materials are supplied to site in both liquid and solid form by bulk tanker, drums and palletised bags (depending on the substance). These materials are loaded into one of the three reaction vessels on site and reacted according to a material order. The finished product is then atomised into various sizes of particles and processed according to customer demands.
- 1.1.4. As part of site changes to production, Abril is proposing to install a new process line which will necessitate additional raw materials and a new emission point to air (to be designated A16).
- 1.1.5. In addition, alongside the new production line, Abril are proposing to install two holding tanks under the reaction vessels at the Installation. These holding tanks would hold finished product wax and have an atmospheric air vent per tank to prevent pressure buildup when filling. These new proposed emission points would be numbered A17 and A18.
- 1.1.6. A process flow diagram of the Installation’s operations, covering the existing and the new process, is provided as Appendix I.
- 1.1.7. Due to the proposed increase to hazardous waste production, the Installation can no longer be classed as a Low Impact Installation (“LII”). Consequently, a permit variation application has been prepared to address these proposed changes.

### 1.2. Installation Location

- 1.2.1. The Installation is located on Sturmi Way, within an industrial estate and heavily industrial site setting area, to the northwest of Bridgend town centre. The Installation occupies an approximate area of 1,200m<sup>2</sup> and is centred on National Grid Reference (“NGR”) SS 83118 82213.
- 1.2.2. The Site Location Plan (Drawing Reference AIWL.01.01-01) details the Environmental Permit boundary (outlined in green) and is provided in Section 5 of this application submission.

### **1.3. The Applicant**

1.3.1. Abril was formed in 1945 and incorporated in 2003. Part of the Hoganas A.B. Group out of Sweden, Abril is a producer of amide waxes and other wax blends for industrial applications.

1.3.2. To enhance their production abilities, the site is proposing to add a new process line.

### **1.4. Pre-Application Advice**

1.4.1. Natural Resources Wales (“NRW”) were approached to assist with determining the correct type of variation to apply for. Based on the advice received, it is understood that, as long as there is no new chemistry with higher hazards, then a normal variation is likely to be appropriate to move from a LII to a bespoke permit. A copy of the email correspondence may be found in Appendix II.

## 2. LISTED ACTIVITIES

### 2.1. Current Activities

2.1.1. The Installation is a permitted Schedule 1 Activity under the Environmental Permitting (England and Wales) Regulations 2016 as amended (“EP Regulations”) and is detailed in Table 1 below. The Installation is currently classified as a LII.

**Table 1: Schedule 1 Activities**

Schedule 1 Activity	Description of Specified Activity	Limits of Specified Activity
Section 4.1 A(1)(a)iv – Producing organic chemicals such as – (iv) organic compounds containing nitrogen	Industrial wax production	Raw materials, handling & storage; Chemical reaction; Effluent control; Finishing products; Packing & storage; Recycling; And Waste handling.
Section 4.1 A(1)(a)(ii) - Producing organic chemicals such as – (ii) organic compounds containing oxygen	Industrial wax production	Raw materials, handling & storage; Chemical reaction; Effluent control; Finishing products; Packing & storage; Recycling; And Waste handling.
Section 4.2 A(1)(a)(i) – Producing inorganic chemicals such as – (i) gases	Production of nitrogen gas	From receipt of raw materials through production and storage of nitrogen gas.

### 2.2. Proposed Activities

2.2.1. There will be no change to the Schedule 1 Activity as a result of this variation application. However, to ensure the Environmental Permit application documents which form part of the Environmental Permit remain reflective of the site operations, this EPTR document details the site expansion proposals, including the introduction of an additional production line and associated equipment, such as raw material and finished product storage and new emission points to air.

2.2.2. The new process will involve the handling of a new diamine, namely: 3,3'-(butane-1,4-diylbis(oxy))bispropaneamine (Baxxodur EC 280, or similar) – hereafter referred to as “New Diamine”. See Appendix III for the Safety Data Sheet (“SDS”) for Baxxodur EC 280.

2.2.3. The handling system will introduce a new air discharge point (designated A16 – refer to the Drawings provided in Section 5) and will be associated with the Local Exhaust Ventilation (“LEV”) system to be installed around the drum handling system. The new process is not

increasing the Installation's reaction capacity, or the amount of effluent produced.

2.2.4. In addition, alongside the new production line, Abril are proposing to install two holding tanks under the reaction vessels at the Installation. These holding tanks would hold finished product wax and have an atmospheric air vent per tank to prevent pressure buildup when filling. These new proposed emission points would be numbered A17 and A18.

2.2.5. The New Diamine is delivered to the Installation in drums, with a maximum on-site storage capacity of 60 x 205 litre drums. As the used drums are removed from the site as hazardous waste, the LII criteria will be exceeded (refer to Section 9.5.2., for further information).

### 3. MANAGEMENT TECHNIQUES

#### 3.1. Overview of Environmental Management System

- 3.1.1. Abril operate an Environmental Management System (“EMS”) which is externally certified to ISO 14001. The ISO 14001 certificate is provided in Appendix IV of this document.
- 3.1.2. The Plant Chemist has overall responsibility for environmental matters at the Installation.
- 3.1.3. Abril has established a documented management system which:
- ensures compliance with all relevant legislation;
  - ensures compliance with the Installation’s Environmental Permit and Trade Effluent Consent;
  - identifies, assesses and minimises the risks of pollution arising from the Installation’s activities;
  - comprises a range of written procedures that cover all aspects of the Installation’s activities;
  - identifies, sets, monitors and reviews environmental objectives and key performance indicators; and
  - includes a requirement to report annually on environmental performance, objectives, targets and future planned improvements.

#### 3.2. Amendments to the Environmental Management System

- 3.2.1. The EMS will be reviewed to take account of the variation to ensure it remains appropriate and effective. The principle anticipated changes are described below:
- update to the management system documents to take account of any additional Environmental Permit conditions, such as any monitoring associated with proposed emission point **A16**;
  - the Environmental Risk Assessment (“ERA”) (AIWL.01.01/ERA) will be used to inform the new risks and opportunities at the Installation and the site specific operational risk assessments forming part of the EMS will be reviewed and any additional control required will be documented;
  - the environmental objectives and targets will take account of the proposed changes to ensure they appropriate;
  - operational procedures will be reviewed to ensure they are aligned with the proposed changes to be introduced as part of the variation;
  - the documented planned maintenance schedule will be updated to include maintenance and inspection related to the new production line and ancillary equipment;
  - emergency plans and procedures will be updated to take account of any additional risks and the requirement for safe start up and shutdown for the new production line;
  - employees will be trained in the updated EMS and associated operational procedures; and
  - all changes to the EMS will be documented and communicated to all employees.

## 4. OPERATING TECHNIQUES

### 4.1. Technical Standards

4.1.1. **European Legislation** - The following European Legislation will be used to inform the variation application:

- the Industrial Emissions Directive (“IED”) is intended to be a single legislative instrument for permitting, compliance and enforcement of environmental legislation across all member states. The requirement of the IED will therefore be considered relevant at this time; and
- the Large Volume Organic Chemicals Best Available Techniques Reference Document (“BREF”) (December 2017) will be considered as it covers Installations associated with the production of organic chemicals.

4.1.2. **National Legislation** – NRW implement the requirements of the IED via the EP Regulations and have provided guidance documents to assist in the preparation of Environmental Permit applications and the ongoing management of permitted Installations. NRW’s ‘*How to comply with your environmental permit*’ (Version 8, October 2014) has been considered in this variation application.

### 4.2. Current Activities

#### Production Capacity

4.2.1. The current LII Permit (reference: EPR/BV5858IW/V004) details the use of two production lines (namely Niro 1 and Niro 2), a powder mixing facility and a separate nitrogen generation and storage facility.

4.2.2. Total maximum daily production capacity of the Installation is 12 tonnes.

#### Existing Emission Points (Air)

4.2.3. **Abril currently has fifteen emission points, designated A1 – A15.** Please refer to the drawings provided in Section 5 of this application submission for more details.

#### Environmental Permit Boundary and Emissions to Foul Sewer and Surface Water

4.2.4. The Environmental Permit boundary and the emission points to sewer and surface water are shown on the Drawings contained within Section 5 of this application submission.

4.2.5. The maximum volume of site effluent permitted to be discharged to sewer is 1m<sup>3</sup>/day.

#### **4.3. Proposed Activities**

##### **Production Capacity**

- 4.3.1. The total maximum daily or annual production capacity of the Installation is not expected to change as the proposed new line will be providing alternative production as opposed to additional production.

##### **Proposed Emission Points**

- 4.3.2. **Three new emission point to air, designated A16 – A18 (inclusive)**, are proposed as part of this variation. This is discussed in detail in Section 5 below.

##### **Environmental Permit Boundary and Emissions to Foul Sewer and Surface Water**

- 4.3.3. No changes are proposed as part of this variation.

## 5. EMISSIONS

### 5.1. Point Source Emissions to Air – Current Arrangements

5.1.1. There are currently fifteen emission points to air, designated as A1 – A15. The locations of these are detailed on the Drawings contained in Section 5 of this application submission.

### 5.2. Point Source Emissions to Air – Proposed Arrangements

5.2.1. Abril is proposing to add three new emission points to air. One of the emission points, designated A16 will be associated with the LEV system for the new process line. In addition, Abril are proposing to install two holding tanks under the reaction vessels – these holding tanks would hold finished product wax and have an atmospheric air vent per tank to prevent pressure buildup when filling. These new proposed emission points would be numbered A17 and A18.

5.2.2. The locations of A16 – A18 (inclusive) are detailed on the Drawings contained in Section 5 of this application submission.

### 5.3. Point Source Emissions to Surface Water – Current Arrangements

5.3.1. There are five point source emissions to surface water, designated W1 – W5. The locations of these are detailed on the Drawings contained in Section 5 of this application submission.

5.3.2. Only clean surface runoff is permitted to be discharged to the surface water drainage network.

### 5.4. Point Source Emissions to Surface Water – Proposed Arrangements

5.4.1. No additional point source emissions to surface water are proposed as part of this variation.

### 5.5. Point Source Emissions to Sewer – Current Arrangements

5.5.1. Process effluent from the site activities is discharged to foul sewer via emission point S1 (refer to the Drawings contained in Section 5 of this application submission for details).

5.5.2. The existing Trade Effluent Consent may be found in Appendix V. Waste effluent is captured via the Installation's effluent system until it reaches circa 1,000 litres. The effluent is then tested to ensure it complies with the Trade Effluent Consent before being released to sewer. Any out of specification effluent is treated to bring the effluent within specification before being released.

5.5.3. The maximum volume of site effluent permitted to be discharged to sewer is 1m<sup>3</sup>/day.

## **5.6. Point Source Emissions to Sewer – Proposed Arrangements**

5.6.1. The quantity of effluent generated on-site is not expected to increase as a result of the new process line. Abril correspondence with Dŵr Cymru Welsh Water has been provided as part of Appendix V which confirms the existing Trade Effluent Consent will also cover the proposed activities.

## **5.7. Point Source Emissions to Land – Current Arrangements**

5.7.1. There are no emissions to land.

## **5.8. Point Source Emissions to Land – Proposed Arrangements**

5.8.1. There are no changes proposed as part of this variation application.

## **5.9. Fugitive Emissions to Air**

5.9.1. The potential sources of fugitive emissions to air from the proposed operations include uncontrolled releases of volatile organic compounds (“VOCs”) from the carbon filter and the LEV system associated with A16.

5.9.2. The operation of the LEV and the carbon filter system will be in accordance with the manufacturer’s instructions. Servicing of the extraction system and discharge point will be undertaken as part of the documented planned maintenance schedule or condition monitoring system which includes all plant and processing equipment. This will ensure optimal performance.

## **5.10. Fugitive Emissions to Surface Water, Sewer and Groundwater**

5.10.1. Fugitive releases to the groundwater will be prevented by conducting all operations in areas sealed with an impervious barrier to prevent a pathway for migration to ground and groundwater. Bunded zones are also present to help prevent emissions to water.

5.10.2. All potentially polluting liquids will be appropriately bunded providing a minimum capacity of either 110% of the capacity of the largest storage vessel or 25% of the total capacity of all the storage vessels within the bund, whichever is greater.

5.10.3. Barriers and signage will be in place to prevent the risk of vehicle collision with storage vessels and bunding.

5.10.4. All plant and equipment will be subject to regular maintenance and servicing as per the Installation’s EMS. In addition, integrity testing of all storage vessels is undertaken by a qualified engineer to reduce the likelihood of tank failure or loss of containment. Site bunding is checked annually. Any remediation action or repairs will be actioned immediately.

- 5.10.5. Regular site inspections are undertaken to identify any evidence of spillages. Additionally, site infrastructure, including bunding and impermeable concrete surfacing is inspected. If remedial action is required, this will be reported immediately and repaired as soon as possible.
- 5.10.6. Any spillages at the Installation will be subject to the robust EMS which includes a spill management procedure (a copy of which has been provided as Appendix VI). This will prevent any potentially polluting materials from entering the Installation's drainage network.
- 5.10.7. All employees are suitably trained in all aspects of the EMS, including spill response, such as the deployment of absorbent mats and drain covers. Spill kits are strategically located and contents regularly inspected and maintained (see Appendix VI). In addition to the Installation's spillage management procedure, all incidents must be reported via the Installation's reporting form (a copy of which has been provided as Appendix VII).

## **5.11. Bund Specification**

- 5.11.1. Abril have confirmed that, subject to the approval of the environmental permit variation application, new bunds will be built in accordance with the CIRIA 736 standard. Abril will make use of an external consultant to advise on this and can provide NRW with the bund documentation once the works have been undertaken.

## **6. GENERAL REQUIREMENTS**

### **6.1. Emissions Management**

6.1.1. The ERA (Document Reference AIWL.01.01/ERA) has demonstrated that emissions of substances not controlled by emission limits (i.e. fugitive emissions) are not considered to be significant, consequently, an Emissions Management Plan is not required as part of this application.

### **6.2. Odour Management**

6.2.1. The production of industrial waxes is not considered to be odorous in nature. In addition, all activities are conducted within a building and appropriate ventilation and extraction systems are in place. Consequently, an Odour Management Plan is not required as part of this application.

### **6.3. Noise Management**

6.3.1. The Installation is located within a predominantly industrial setting and the following measures will be in place:

- appropriate location of equipment - processing activities undertaken within the site buildings to achieve noise attenuation;
- regular inspection and maintenance of equipment to ensure good working order;
- operation of equipment by experienced personnel;
- closing of doors when not in use;
- avoidance of potentially noise emitting activities during night-time hours where possible;
- use of low noise equipment where possible, such as fans and pumps; and
- training of all staff and contractors to report any identified abnormal noise levels on site to enable the cause to be addressed immediately.

6.3.2. The ERA has demonstrated that noise emissions are not considered to be significant. Consequently, a Noise Management Plan is not required as part of this application.

### **6.4. Pest Management**

6.4.1. Due to the nature of the process, and with all activities conducted within a building, with all materials contained and stored appropriately, the likelihood of the attraction of pests at the Installation is considered to be very low. Consequently, a Pest Management Plan is not required as part of this application.

## 6.5. Fire Management

- 6.5.1. As part of Abril's EMS, the Installation has an Emergency Plan in place which details the procedures to report and effectively manage incidents and potential emergency situations including fire.
- 6.5.2. Fire risk management is detailed in the ERA (see Section 4 of this application submission) and are summarised below:
- fire extinguisher and fire alarms are located in strategic locations throughout the Installation and are tested and maintained periodically;
  - fire risk assessments are undertaken by suitably qualified personnel;
  - evacuation drills are undertaken to ensure all staff are aware of the emergency procedures;
  - preventative maintenance on all equipment is undertaken to prevent any faults occurring;
  - smoking is prohibited on-site; and
  - firewater will be contained using bunds and booms and the firewater would then be tankered off site to an appropriately licenced Facility. Drain mats will be deployed to prevent any firewater from entering the drainage system.
- 6.5.3. In addition to the above, all incidents must be reported via the Installation's reporting form (a copy of which has been provided as Appendix VII).

## 7. MONITORING

### 7.1. Monitoring of Emissions to Air – Current Arrangements

7.1.1. The current monitoring requirements for emissions to air are daily visual inspections for particulates (both of the bag filtration equipment and emission points to air) for emission points A2 – A4 (inclusive), A12 and A14 (refer to the Drawings contained in Section 5 of this application submission for details). No visible releases are permitted and the reporting period to NRW is quarterly.

### 7.2. Monitoring of Emissions to Air – Proposed Arrangements

7.2.1. **Abril is proposing to add three new emission points, designated A16 – A18 (inclusive). A16 will be associated with the LEV system for the new process line. It is understood that a carbon filter will be fitted to minimise any VOC releases to atmosphere. It is anticipated that daily inspections of the filter and emission point to air will be undertaken in accordance with BAT and reported at the frequency to be specified by NRW. The filter will be replaced when required.**

7.2.2. **In addition, alongside the new production line, Abril are proposing to install two holding tanks under the reaction vessels at the Installation. These holding tanks would hold finished product wax and have an atmospheric air vent per tank to prevent pressure buildup when filling. These new proposed emission points would be numbered A17 and A18.**

7.2.3. **It should be noted that as proposed emission points A17 and A18 will solely be present to avoid any overpressure of the holding tanks, it is considered that there will be negligible emissions associated with them. Consequently, these emission points will not need to be factored into the H1 air emissions risk assessment.**

7.2.4. A H1 air emissions risk assessment was undertaken (a copy of which is contained in Section 6 of this application submission), which concluded that the impacts associated with the Installation and operation of proposed emission point **A16** are not considered to be significant.

### 7.3. Monitoring of Groundwater and Soil

7.3.1. Fugitive releases to the groundwater or soil will be prevented by conducting all operations in areas sealed with an impervious barrier to prevent a pathway for migration to ground or groundwater. We anticipate that groundwater monitoring every 5 years will be required, as well as soil monitoring every 10 years.

### 7.4. Monitoring of Surface Water – Current Arrangements

7.4.1. There are five point source emissions to surface water, designated W1 – W5. The locations of these are detailed on the Drawings contained in Section 5 of this application submission.

7.4.2. Only clean surface (rainwater) runoff is permitted to be discharged to the surface water drainage network. Therefore, no monitoring of surface water is currently undertaken.

**7.5. Monitoring of Surface Water – Proposed Arrangements**

7.5.1. No additional point source emissions to surface water are proposed as part of this variation. Therefore, no monitoring of surface water is proposed.

**7.6. Monitoring of Foul Water – Current Arrangements**

7.6.1. The current S1 monitoring requirements contained in the Environmental Permit are reproduced in Table 2.

**Table 2: S1 Monitoring Requirements**

Emission Point	Substance or Parameter	Monitoring Frequency
S1	Oil and grease	Every 3 months
	Chemical oxygen demand (maximum)	
	Chemical oxygen demand (average)	
	Suspended solids	
	pH maximum	
	pH minimum	
	pH average	
	Total flow	

7.6.2. The current Environmental Permit also contains limits for the emissions to sewer as detailed in Table 3.

**Table 3: S1 Emissions Limits and Monitoring Frequency to Sewer**

Emission Point	Substance or Parameter	Limit	Monitoring Frequency
S1	Oil and grease	50 mg/l	Monthly
	Chemical oxygen demand	20,000 mg/l	Monthly
	Suspended solids	400 mg/l	Monthly
	pH maximum	10.0	Monthly
	pH minimum	6.0	Monthly
	Temperature	43°C	Monthly
	Flow	1,000 l/day	Daily

7.6.3. Additionally, periodic monitoring is undertaken by Dŵr Cymru Welsh Water to ensure Abril are adhering to their Trade Effluent Consent which is contained in Appendix V.

## **7.7. Monitoring of Foul Water – Proposed Arrangements**

7.7.1. The quantity of effluent generated on-site is not expected to increase as a result of the new process line. Abril correspondence with Dŵr Cymru Welsh Water has been provided as part of Appendix V which confirms the existing Trade Effluent Consent will also cover the proposed activities. The proposed activity does not involve discharging any hazardous chemicals or elements to sewer; a H1 assessment to sewer is therefore not required.

## 8. RESOURCE EFFICIENCY AND CLIMATE CHANGE

### 8.1. Energy Efficiency Measures

- 8.1.1. A number of energy efficiency measures will be implemented at the Installation, such as:
- ensuring regular inspection and maintenance of equipment and plant to achieve optimum efficiency;
  - optimising operational planning to streamline equipment and plant use;
  - all new lighting is energy efficient light-emitting diode (“LED”);
  - employees will be trained in the importance of energy management and basic energy saving practices; and
  - all electricity used on-site is produced entirely from renewable energy sources.
- 8.1.2. Energy consumption will be monitored and reviewed quarterly. Key performance indicators will be set annually with planned periodic improvement targets and related actions detailed; this will form part of the Installation’s EMS. Energy Consumption and CO<sub>2</sub> production is also reported quarterly to NRW.

### 8.2. Energy Consumption

- 8.2.1. Abril has recorded an average annual energy consumption of approximately 1,378 MWh, based on 2016-2023 performance data. It should be noted that the Installation’s electricity is generated from 100% renewables. Abril have provided their energy trends use data, which has been summarised in Table 4.

**Table 4: Energy Consumption**

Year	Energy Source	Primary Energy (MWh)	CO <sub>2</sub> Produced (tonnes)	CO <sub>2</sub> (per unit output)
2016	Electricity	1,639	76.1	0.048
2017		1,807	83.7	0.044
2018		1,950	93.4	0.044
2019		1,600	78.6	0.043
2020		1,113	205	0.14
2021		1,360	171	0.12
2022		783	77.7	0.045
2023		771	75.4	0.051
<b>Average</b>		<b>1,378</b>	<b>108</b>	<b>0.067</b>

- 8.2.2. The proposed changes at the Installation are not expected to significantly increase or decrease the site’s average annual energy usage.

### **8.3. Climate Change Agreement**

- 8.3.1. Abril are not currently part of a Climate Change Agreement (“CCA”) but are committed to reducing energy consumption and associated carbon dioxide (“CO<sub>2</sub>”) emissions as detailed in Section 9.1.
- 8.3.2. All electricity used on-site is produced entirely from renewable energy sources.

### **8.4. Raw Material Justification and Waste Minimisation**

#### **Raw Material Justification**

- 8.4.1. The raw materials (i.e., various fatty acids) are supplied to Abril in both liquid and solid form by bulk tanker, drums and palletised bags, depending on the substance. These materials are loaded into one of the three reaction vessels on-site and reacted according to a material order. The finished product is then atomised into various sizes of particles and processed according to customer demands.
- 8.4.2. The amines (ethylenediamine and the New Diamine) are delivered in liquid form. The Installation’s maximum storage capacity of ethylenediamine is approximately 15 tonnes (contained within a 20,000 litre tank) and 60 x 205 litre drums of New Diamine (as the used New Diamine drums are removed from the site as hazardous waste, the LII criteria will be exceeded).
- 8.4.3. The new process will not increase the Installation’s reaction capacity or the amount of effluent produced.
- 8.4.4. Abril’s EMS will include a procedure for the annual review of raw material usage and new developments in raw materials and for the implementation of any suitable ones with an improved environmental profile.
- 8.4.5. No major increase to the Installation’s water consumption is expected as a result of the proposed changes on-site. The Installation’s water consumption for the preceding five years averaged approximately 200m<sup>3</sup> per year (and was 158m<sup>3</sup> in the last 12 months).
- 8.4.6. It is anticipated the average water consumption figure of 200m<sup>3</sup> per year will remain representative as the only anticipated increase to the water consumed on-site will be from the periodic washing of the new equipment.

#### **Waste Minimisation**

- 8.4.7. As raw materials are reacted and processed according to specific customer demands, this ensures waste production at the Installation is minimal as only the necessary quantities are utilised.
- 8.4.8. The empty drums from the New Diamine will be collected as hazardous waste from the Installation and sent to a suitably licenced facility to undergo recovery and / or disposal activities. It is anticipated that up to 250 drums of the New Diamine will be used on-site annually.

- 8.4.9. As Abril will produce more than 10kg of hazardous waste per day, averaged over a year and more than 200kg of hazardous waste being produced in any one day, the LII criteria will no longer be met hence the requirement for the permit variation.
- 8.4.10. Following the installation of the new process line, waste reporting within the first year will allow Abril to set a baseline against which improvement targets for the Installation can be set as part of the EMS.

## **9. COMPLIANCE WITH BAT CONCLUSIONS**

### **9.1. Overview**

- 9.1.1. It is considered that the techniques that will be in use at the Installation will constitute Best Available Techniques (“BAT”) and will be appropriate and proportionate for the scale of the activities at the Installation and the risks that are posed to the environment by these activities.
- 9.1.2. The BAT Requirements from the Large Volume Organic Chemicals BREF (December 2017) will be considered as it covers Installations associated with the production of organic chemicals. These BAT conclusions apply without prejudice to other relevant legislation, such as health and safety.
- 9.1.3. A demonstration of compliance with applicable BAT is provided in Table 5.

**Table 5: Large Volume Organic Chemicals BREF - General BAT Conclusions**

BAT Ref No.	BAT Requirement	Section of Supporting Documents
<b>Monitoring of emissions to air</b>		
2	BAT is to monitor channelled emissions to air other than from process furnaces/heaters in accordance with EN standards and with at least the minimum frequency given in the table. If EN standards are not available, BAT is to use ISO, national or other international standards that ensure the provision of data of an equivalent scientific quality.	EPTR - Sections 8.1 and 8.2.
8	In order to reduce the load of pollutants sent to the final waste gas treatment, and to increase resource efficiency, BAT is to use an appropriate combination of the techniques given in the table for process off-gas streams (for example: (a) recovery and use of excess or generated hydrogen, (b) recovery and use of organic solvents and unreacted organic raw materials, (c) use of spent air and (f) techniques to reduce solids and/or liquids entrainment	EPTR – Sections 3, 9.4 and 9.5.
10	In order to reduce channelled emissions of organic compounds to air, BAT is to use one or a combination of the following techniques: (a) Condensation (b) Adsorption (c) Wet scrubbing (d) Catalytic oxidiser (e) Thermal oxidiser	EPTR Sections 7.1 and 7.2
11	In order to reduce channelled dust emissions to air, BAT is to use one or a combination of the following techniques: (a) Cyclone (b) Electrostatic precipitator (c) Fabric filter (d) Two-stage dust filter (e) Ceramic/metal filter (f) Wet dust scrubbing	EPTR - Sections 7.1 and 7.2.

**Table 5: Large Volume Organic Chemicals BREF - General BAT Conclusions (cont.)**

BAT Ref No.	BAT Requirement	Section of Supporting Documents
<b>Emissions to water</b>		
14	In order to reduce the waste water volume, the pollutant loads discharged to a suitable final treatment (typically biological treatment), and emissions to water, BAT is to use an integrated waste water management and treatment strategy that includes an appropriate combination of process-integrated techniques, techniques to recover pollutants at source, and pretreatment techniques, based on the information provided by the inventory of waste water streams specified in the <i>Common Waste Water and Waste Gas Treatment/Management Systems in the Chemical Sector</i> BAT conclusions.	EPTR – Sections 3, 5.5, 7.6, 7.7 and 8.4
<b>Resource Efficiency</b>		
16	In order to increase resource efficiency, BAT is to recover and reuse organic solvents. Organic solvents used in processes (e.g. chemical reactions) or operations (e.g. extraction) are recovered using appropriate techniques (e.g. distillation or liquid phase separation), purified if necessary (e.g. using distillation, adsorption, stripping or filtration) and returned to the process or operation. The amount recovered and reused is process-specific.	EPTR - Sections 3 and 8
<b>Residues</b>		
17	In order to prevent or, where that is not practicable, to reduce the amount of waste being sent for disposal, BAT is to use an appropriate combination of the techniques given in the table.	EPTR - Sections 3 and 8
<b>Other than normal operating conditions</b>		
18	In order to prevent or reduce emissions from equipment malfunctions, BAT is to use all of the following techniques: (a) Identification of critical equipment (b) Asset reliability programme for critical equipment (c) Back-up systems for critical equipment	EPTR – Section 3
19	In order to prevent or reduce emissions to air and water occurring during other than normal operating conditions, BAT is to implement measures commensurate with the relevance of potential pollutant releases for: (i) Start-up and shutdown operations; (ii) other circumstances (e.g. regular and extraordinary maintenance work and cleaning operations of the units and/or of the waste gas treatment system) including those that could affect the proper functioning of the installation.	EPTR – Section 3

## **APPENDIX I PROCESS FLOW DIAGRAM**

- Existing process: Amide wax synthesis
- Existing Process: Effluent analysis & neutralization
- New Process: Material handling & value chain
- New Process: Hazardous waste, Air & Effluent

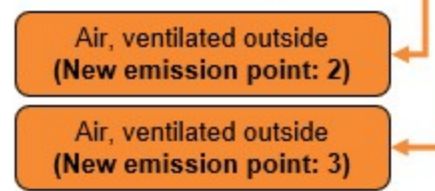
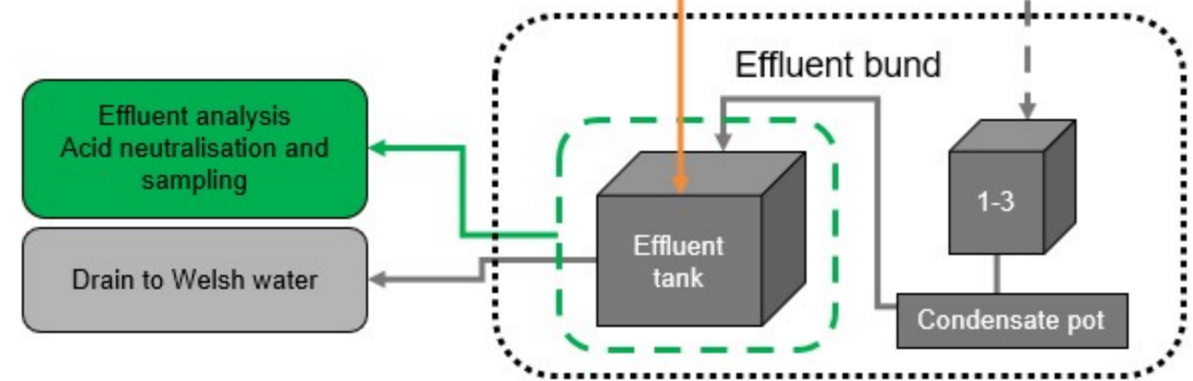
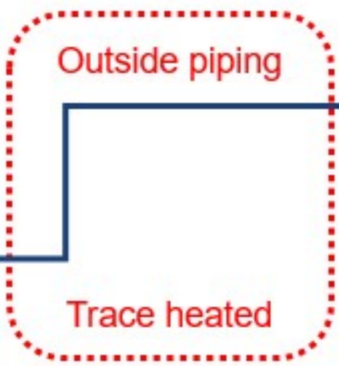
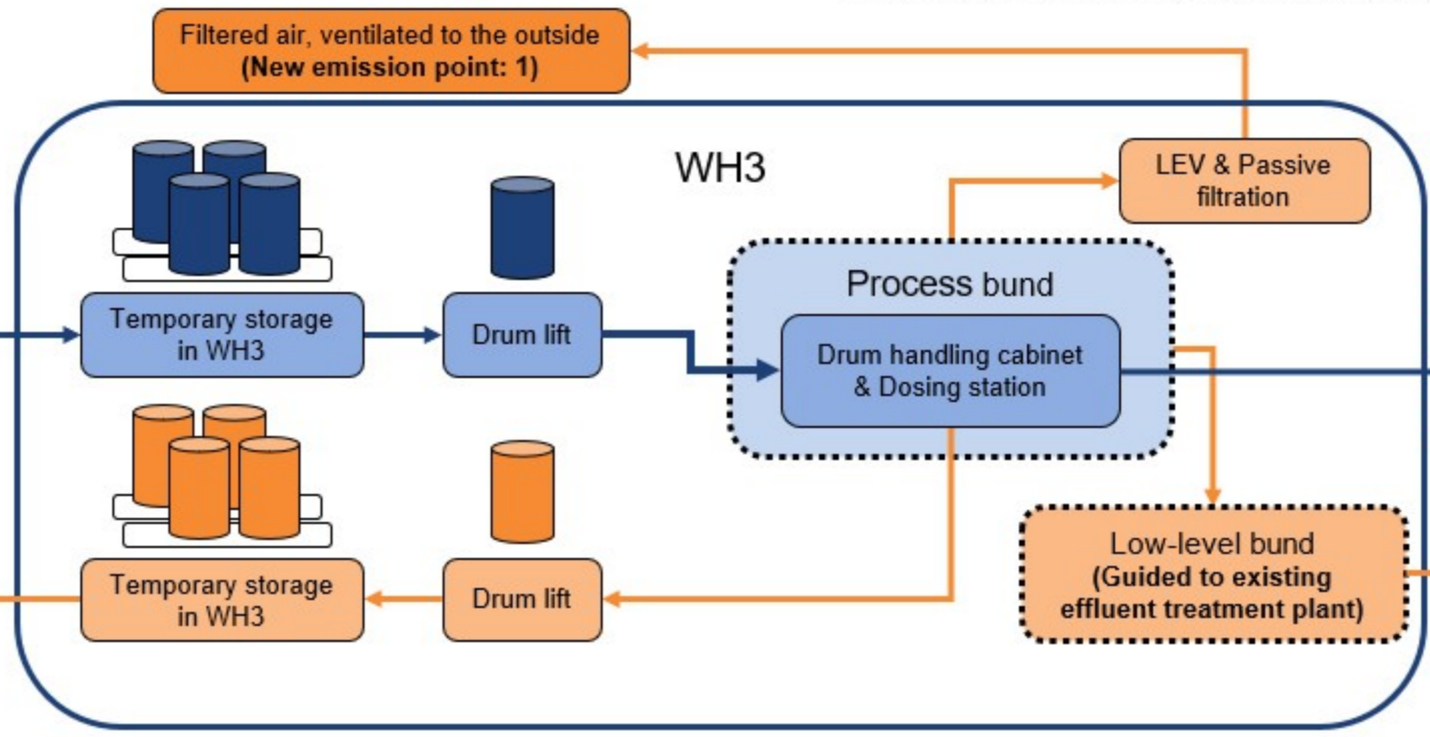
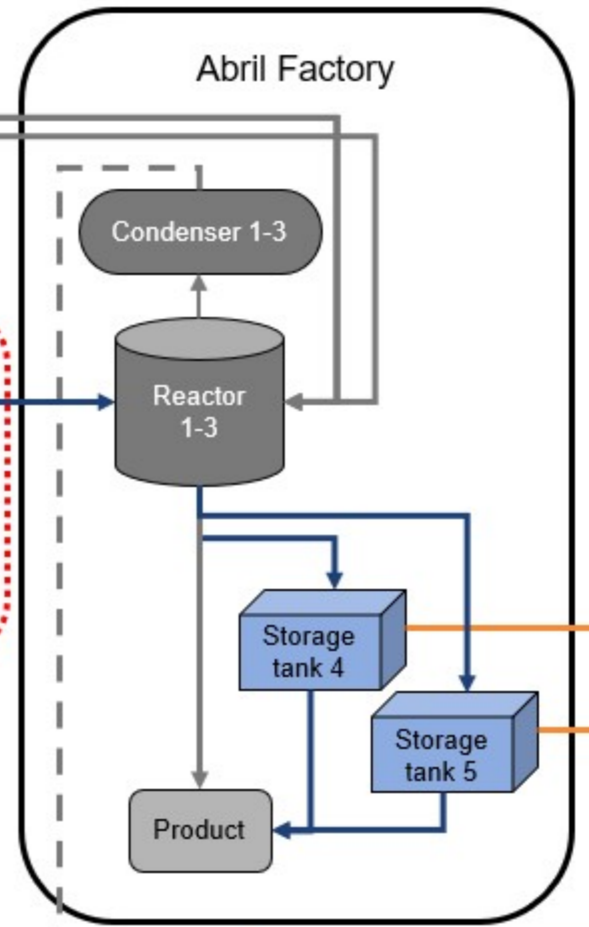
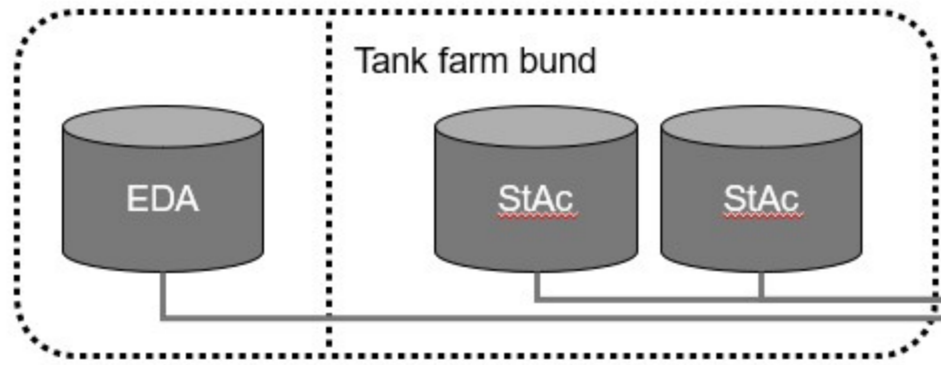

**APPENDIX II  
PRE-APPLICATION ADVICE**

---

**From:** Brigid Armstead <Brigid.Armstead@cyfoethnaturiolcymru.gov.uk>  
**Sent:** 17 July 2024 12:45  
**To:** Tim Heard  
**Cc:** Padfield, Dale  
**Subject:** RE: Abril Industrial Waxes Limited, Pyle - Permit Variation Query

Hi Tim,

Thanks for contacting us to let us know that you will be assisting with this variation application. Please refer to our [website](#) for Permit variation application resources.

As long as there is no new chemistry with higher hazards, then a normal variation fee is likely to be appropriate to move from LII to a bespoke permit. The key criteria for requiring substantial change is the need for public consultation and/or potential for significant environmental impact. Please refer to [RGN8](#) when determining the type of variation.

The Schedule 1 activity doesn't need to change unless the chemistry TYPE (e.g. from producing compounds containing nitrogen and/or oxygen to compounds containing halogens) has changed, but there will need to be a description of the new chemistry in terms of potential for emissions and accident hazards, as well as production of new waste streams. Any new plant and equipment, including control systems, also need description and environmental risk assessment (e.g. for new noise impacts, accident hazards, fugitive emissions, etc...).

If the site is no longer a LII there may be some additional amendments to the permit. Most notably the operating techniques (table S1.2) as LIIs operate to the LII criteria (set out when the original application was submitted) but if the site is no longer LII, we would need to integrate the site's operating techniques into the permit, so the applicant will need to supply these with the variation application. In terms of forms they just need to submit the usual ones for a variation (form part A, Part C2, Part C3 and part f). We will also require a new EPR OPRA spreadsheet with the application to enable us to calculate subsistence charges, which will move from fixed fee for LII to EPR OPRA-based fee.

Current permitting delay for allocation of applications is between 6 and 12 months.

Best regards,

**Enw / Brigid Armstead**  
**Teitl swydd / Senior Officer Industry & Waste Regulation**  
**Adran / South Central Industry Regulation**  
**Rhif ffôn / 0300 065 3765**  
**Dyddiau gweithio/ Monday-Friday**  
**Rhagenwau/ She/Her**

**Croesewir gohebiaeth yn Gymraeg a byddwn yn ymateb yn Gymraeg, heb i hynny arwain at oedi.**

Correspondence in Welsh is welcomed, and we will respond in Welsh without it leading to a delay.



**Cyfoeth  
Naturiol  
Cymru**  
**Natural  
Resources  
Wales**

**Byd natur a phobl  
yn ffynnu gyda'n gilydd**

**Nature and people  
thriving together**



**cyfoethnaturiol.cymru  
naturalresources.wales**

**From:** Tim Heard <t.heard@ecl.world>

**Sent:** Tuesday, July 16, 2024 3:05 PM

**To:** Brigid Armstead <Brigid.Armstead@cyfoethnaturiolcymru.gov.uk>; Padfield, Dale  
<dale.padfield@cyfoethnaturiolcymru.gov.uk>

**Cc:** Robbins Kenneth <KRobbins@abril.co.uk>; Karlsson Emil <Emil.Karlsson@hogas.com>; Sarah Cann  
<s.cann@ecl.world>; Sara Maile <s.maile@ecl.world>

**Subject:** Abril Industrial Waxes Limited, Pyle - Permit Variation Query

Some people who received this message don't often get email from [t.heard@ecl.world](mailto:t.heard@ecl.world). [Learn why this is important](#)

**Rhybudd:** Deilliodd yr e-bost hwn o'r tu allan i'r sefydliad. Peidiwch â chlicio dolenni, atodiadau agored nac sganio codau QR oni bai eich bod yn cydnabod yr anfonwr ac yn gwybod bod y cynnwys yn ddiogel.

**Caution:** This email originated from outside of the organisation. Do not click links, open attachments or scan QR Codes unless you recognise the sender and know the content is safe.

Hi Both,

I hope this email finds you well.

Further to the attached CAR, ECL have been appointed by Abril Industrial Waxes Limited to assist with the preparation of an Environmental Permit ("EP") variation application.

To help serve as a reminder and/or to provide context: As part of changes to production at the Installation, Abril is proposing to install a new process line which will necessitate additional raw materials (namely: Baxxodur 280) and a new emission point to air, to be designated A15.

If possible, for the purposes of calculating the application fee via NRW's charge banding tool spreadsheet, we were hoping to raise the below queries with you:

- will varying the EP from a Low Impact Installation ("LII") to an Installation be classed as a normal variation due to the minor change? As we understand that the only reason the LII criteria will be exceeded is due to the fact the used Baxxodur 280 drums will need to be removed from the site as hazardous waste; and
- from our understanding, as the proposed process is intended to provide alternative production, and the site's reaction capacity will not increase, it will just be activity references A1 and A2 (please refer to the below screen capture for ease of reference) that will be affected by the variation and need to be specified on the Listed Activity tab?

**Table S1.1.1 activities**

<b>Activity reference</b>	<b>Activity listed in Schedule 1 of the EP Regulations</b>	<b>Description of specified activity</b>	<b>Limits of specified activity and waste types</b>
A1	Section 4.1A1(a)(iv)Producing organic chemicals such as- (iv)organic compounds containing nitrogen	Industrial Wax Production	Raw materials handling and storage, chemical reaction, effluent control, finishing products, packaging and storage, recycling and waste handling.
A2	Section 4.1A1(a)(ii)Producing organic chemicals such as- (ii) organic compounds containing oxygen	Industrial Wax Production	Raw materials handling and storage, chemical reaction, effluent control, finishing products, packaging and storage, recycling and waste handling.
A3	Section 4.2A1(a)(i) Producing inorganic chemicals such as— (i) gases	Production of Nitrogen Gas	From receipt of raw materials through production and storage of Nitrogen gas.
<b>Directly Associated Activity</b>			
-	-	-	-

In addition, I understand Abril were previously advised that NRW’s approximate timescales for the allocation of an EP variation application is 12 months - please could we just check if this is still the case?

Kind regards,

**Tim Heard**  
Associate Consultant

Tel: 01443 801215  
Mob: 07976182544  
Website: [www.ecl.world](http://www.ecl.world)



The contents of this email and the information or attachments contained within are private and confidential and are the property of Environmental Compliance Limited, Registered Office: Unit G1, Main Avenue, Treforest Industrial Estate, Pontypridd, CF37 5BF, Company Number: 4249446.

This email and any attachments are intended for the confidential use of the named recipient(s) only. If you are not the intended recipient, you must not copy, distribute, or take any action in reliance on it. If you have received this email in error, please contact us immediately, destroy all copies and delete the message from your computer system.

Please consider the environment before printing this e-mail

**APPENDIX III  
BAXXODUR 280 SAFETY DATA SHEET**

# Safety data sheet

Page: 1/76

---

BASF Safety data sheet according to Regulation UK SI 2019/758 and UK SI 2020/1577 as amended from time to time.

Date / Revised: 15.12.2022

Version: 11.0

Date previous version: 29.03.2022

Previous version: 10.0

Date / First version: 08.08.2002

Product: **Baxxodur® EC 280**

(ID no. 30340659/SDS\_GEN\_GB/EN)

Date of print 26.02.2024

---

## SECTION 1: Identification of the substance/mixture and of the company/undertaking

### 1.1. Product identifier

#### **Baxxodur® EC 280**

Chemical name: 3,3'-(butane-1,4-diylbis(oxy))bispropaneamine

CAS Number: 7300-34-7

REACH registration number: 01-2119978237-25-0000

### 1.2. Relevant identified uses of the substance or mixture and uses advised against

Relevant identified uses: Chemical used in synthesis and/or formulation of industrial products

For the detailed identified uses of the product see appendix of the safety data sheet.

### 1.3. Details of the supplier of the safety data sheet

Company:

BASF plc

4th and 5th Floors

2 Stockport Exchange

Railway Road, Stockport, SK1 3GG

UNITED KINGDOM

Telephone: +44 161 475 3000

E-mail address: product-safety-uk-and-ireland@basf.com

### 1.4. Emergency telephone number

Telephone: +49 180 2273-112

---

## SECTION 2: Hazards Identification

### 2.1. Classification of the substance or mixture

BASF Safety data sheet according to Regulation UK SI 2019/758 and UK SI 2020/1577 as amended from time to time.

Date / Revised: 15.12.2022

Version: 11.0

Date previous version: 29.03.2022

Previous version: 10.0

Date / First version: 08.08.2002

Product: **Baxxodur® EC 280**

(ID no. 30340659/SDS\_GEN\_GB/EN)

Date of print 26.02.2024

According to GB-CLP Regulations UK SI 2019/720 and UK SI 2020/1567

Acute Tox. 4 (Inhalation - mist)	H332 Harmful if inhaled.
Skin Corr./Irrit. 1B	H314 Causes severe skin burns and eye damage.
Eye Dam./Irrit. 1	H318 Causes serious eye damage.
Skin Sens. 1	H317 May cause an allergic skin reaction.

For the classifications not written out in full in this section the full text can be found in section 16.

## 2.2. Label elements

According to GB-CLP Regulations UK SI 2019/720 and UK SI 2020/1567

Pictogram:



Signal Word:

Danger

Hazard Statement:

H332	Harmful if inhaled.
H317	May cause an allergic skin reaction.
H314	Causes severe skin burns and eye damage.

Precautionary Statements (Prevention):

P280	Wear protective gloves, protective clothing and eye protection or face protection.
P271	Use only outdoors or in a well-ventilated area.

Precautionary Statements (Response):

P310	Immediately call a POISON CENTER or physician.
P305 + P351 + P338	IF IN EYES: Rinse cautiously with water for several minutes. Remove contact lenses, if present and easy to do. Continue rinsing.

Precautionary Statements (Storage):

P405	Store locked up.
------	------------------

Precautionary Statements (Disposal):

P501	Dispose of contents and container to hazardous or special waste collection point.
------	---

Hazard determining component(s) for labelling: 3,3'-[Butane-1,4-diylbis(oxy)]bispropanamine

## 2.3. Other hazards

According to GB-CLP Regulations UK SI 2019/720 and UK SI 2020/1567

BASF Safety data sheet according to Regulation UK SI 2019/758 and UK SI 2020/1577 as amended from time to time.

Date / Revised: 15.12.2022

Version: 11.0

Date previous version: 29.03.2022

Previous version: 10.0

Date / First version: 08.08.2002

Product: **Baxxodur® EC 280**

(ID no. 30340659/SDS\_GEN\_GB/EN)

Date of print 26.02.2024

If applicable information is provided in this section on other hazards which do not result in classification but which may contribute to the overall hazards of the substance or mixture.

Product does not contain a substance above legal limits included in the list established in accordance with Article 59(1) of Regulation (EC) No 1907/2006 for having endocrine disrupting properties or is identified to have endocrine disrupting properties in accordance with the criteria set out in Commission Delegated Regulation (EU) 2017/2100 or Commission Regulation (EU) 2018/605.

## SECTION 3: Composition/Information on Ingredients

### 3.1. Substances

#### Chemical nature

ether amines

#### Hazardous ingredients (GHS)

| 3,3'-[Butane-1,4-diylbis(oxy)]bispropanamine

Content (W/W): >= 98.5 % - <=

99.8 %

CAS Number: 7300-34-7

EC-Number: 230-745-9

Acute Tox. 4 (Inhalation - mist)

Skin Corr./Irrit. 1B

Eye Dam./Irrit. 1

Skin Sens. 1

H332, H317, H314

For the classifications not written out in full in this section, including the hazard classes and the hazard statements, the full text is listed in section 16.

### 3.2. Mixtures

Not applicable

## SECTION 4: First-Aid Measures

### 4.1. Description of first aid measures

Immediately remove contaminated clothing. If the patient is likely to become unconscious, place and transport in stable sideways position (recovery position). If not breathing, give artificial respiration. First aid personnel should pay attention to their own safety.

If inhaled:

Keep patient calm, remove to fresh air, seek medical attention. Immediately administer a corticosteroid from a controlled/metered dose inhaler.

---

BASF Safety data sheet according to Regulation UK SI 2019/758 and UK SI 2020/1577 as amended from time to time.

Date / Revised: 15.12.2022

Version: 11.0

Date previous version: 29.03.2022

Previous version: 10.0

Date / First version: 08.08.2002

Product: **Baxxodur® EC 280**

(ID no. 30340659/SDS\_GEN\_GB/EN)

Date of print 26.02.2024

---

On skin contact:

Immediately wash thoroughly with plenty of water, apply sterile dressings, consult a skin specialist.

On contact with eyes:

Immediately wash affected eyes for at least 15 minutes under running water with eyelids held open, consult an eye specialist.

On ingestion:

Do not induce vomiting. Immediately rinse mouth and then drink 200-300 ml of water, seek medical attention.

#### **4.2. Most important symptoms and effects, both acute and delayed**

Symptoms: Information, i.e. additional information on symptoms and effects may be included in the GHS labeling phrases available in Section 2 and in the Toxicological assessments available in Section 11., Further symptoms are possible

#### **4.3. Indication of any immediate medical attention and special treatment needed**

Treatment: Treat according to symptoms (decontamination, vital functions), no known specific antidote. Pulmonary odema prophylaxis. Medical monitoring for at least 24 hours.

---

## **SECTION 5: Fire-Fighting Measures**

### **5.1. Extinguishing media**

Suitable extinguishing media:

water spray, dry powder, foam, carbon dioxide

### **5.2. Special hazards arising from the substance or mixture**

Endangering substances: nitrogen oxides, carbon oxides

Advice: The substances/groups of substances mentioned can be released in case of fire. Under certain conditions in case of fire other hazardous combustion products may be generated.

### **5.3. Advice for fire-fighters**

Special protective equipment:

Wear self-contained breathing apparatus and chemical-protective clothing.

Further information:

Dispose of fire debris and contaminated extinguishing water in accordance with official regulations.

---

## **SECTION 6: Accidental Release Measures**

### **6.1. Personal precautions, protective equipment and emergency procedures**

Use personal protective clothing. Information regarding personal protective measures, see section 8. Avoid inhalation. Avoid contact with the skin, eyes and clothing.

### **6.2. Environmental precautions**

Do not discharge into drains/surface waters/groundwater.

---

BASF Safety data sheet according to Regulation UK SI 2019/758 and UK SI 2020/1577 as amended from time to time.

Date / Revised: 15.12.2022

Version: 11.0

Date previous version: 29.03.2022

Previous version: 10.0

Date / First version: 08.08.2002

Product: **Baxxodur® EC 280**

(ID no. 30340659/SDS\_GEN\_GB/EN)

Date of print 26.02.2024

---

### 6.3. Methods and material for containment and cleaning up

For small amounts: Pick up with suitable appliance and dispose of.

For large amounts: Pick up with suitable appliance and dispose of.

Cleaning operations should be carried out only while wearing breathing apparatus. Wear suitable protective equipment. Clean contaminated floors and objects thoroughly with water and detergents, observing environmental regulations. Collect waste in suitable containers, which can be labeled and sealed. Incinerate or take to a special waste disposal site in accordance with local authority regulations.

### 6.4. Reference to other sections

Information regarding exposure controls/personal protection and disposal considerations can be found in section 8 and 13.

---

## SECTION 7: Handling and Storage

### 7.1. Precautions for safe handling

Ensure thorough ventilation of stores and work areas. Avoid aerosol formation. Handle in accordance with good industrial hygiene and safety practice.

Protection against fire and explosion:

Prevent electrostatic charge - sources of ignition should be kept well clear - fire extinguishers should be kept handy.

### 7.2. Conditions for safe storage, including any incompatibilities

Segregate from acids and acid forming substances.

Suitable materials for containers: Carbon steel (Iron), Stainless steel 1.4401, Stainless steel 1.4301 (V2), High density polyethylene (HDPE), glass, Low density polyethylene (LDPE)

Unsuitable materials for containers: Galvanized carbon steel (Zinc), Paper/Fibreboard

Further information on storage conditions: Keep container tightly closed and in a well-ventilated place.

Storage stability:

Storage duration: 24 Months

From the data on storage duration in this safety data sheet no agreed statement regarding the warrantee of application properties can be deduced.

### 7.3. Specific end use(s)

See exposure scenario(s) in the attachment to this safety data sheet.

---

## SECTION 8: Exposure Controls/Personal Protection

### 8.1. Control parameters

Components with occupational exposure limits

| No substance specific occupational exposure limits known.

BASF Safety data sheet according to Regulation UK SI 2019/758 and UK SI 2020/1577 as amended from time to time.

Date / Revised: 15.12.2022

Version: 11.0

Date previous version: 29.03.2022

Previous version: 10.0

Date / First version: 08.08.2002

Product: **Baxxodur® EC 280**

(ID no. 30340659/SDS\_GEN\_GB/EN)

Date of print 26.02.2024

#### PNEC

freshwater: 0.22 mg/l

marine water: 0.022 mg/l

intermittent release: 2.2 mg/l

sediment (freshwater): 1.45 mg/kg

sediment (marine water): 0.145 mg/kg

soil: 0.161 mg/kg

STP: 65.3 mg/l

oral (secondary poisoning):

No PNEC oral derived, as accumulation in organisms is not to be expected.

#### DNEL

worker:

Long-term exposure- systemic effects, Inhalation: 59 mg/m<sup>3</sup>

worker:

Short-term exposure - systemic effects, Inhalation: 176 mg/m<sup>3</sup>

worker:

Long-term exposure - local effects, Inhalation: 1 mg/m<sup>3</sup>

worker:

Short-term exposure - local effects, Inhalation: 13 mg/m<sup>3</sup>

worker:

Long-term exposure- systemic effects, dermal: 8.3 mg/kg

## **8.2. Exposure controls**

### Personal protective equipment

Respiratory protection:

Respiratory protection in case of vapour/aerosol release. Combination filter for gases/vapours of organic compounds and solid and liquid particles (f.e. EN 14387 Type A-P2)

Consider the risk management measures as outlined in the exposure scenario.

Hand protection:

Chemical resistant protective gloves (EN ISO 374-1)

BASF Safety data sheet according to Regulation UK SI 2019/758 and UK SI 2020/1577 as amended from time to time.

Date / Revised: 15.12.2022

Version: 11.0

Date previous version: 29.03.2022

Previous version: 10.0

Date / First version: 08.08.2002

Product: **Baxxodur® EC 280**

(ID no. 30340659/SDS\_GEN\_GB/EN)

Date of print 26.02.2024

Suitable materials also with prolonged, direct contact (Recommended: Protective index 6, corresponding > 480 minutes of permeation time according to EN ISO 374-1):

butyl rubber (butyl) - 0.7 mm coating thickness

Manufacturer's directions for use should be observed because of great diversity of types.

Supplementary note: The specifications are based on tests, literature data and information of glove manufacturers or are derived from similar substances by analogy. Due to many conditions (e.g. temperature) it must be considered, that the practical usage of a chemical-protective glove in practice may be much shorter than the permeation time determined through testing.

Consider the risk management measures as outlined in the exposure scenario.

Eye protection:

Tightly fitting safety goggles (cage goggles) (e.g. EN 166) and face shield.

Consider the risk management measures as outlined in the exposure scenario.

Body protection:

chemical-protection suit (f.e. according to EN 14605)

Consider the risk management measures as outlined in the exposure scenario.

#### General safety and hygiene measures

Handle in accordance with good industrial hygiene and safety practice. Wearing of closed work clothing is required additionally to the stated personal protection equipment. Avoid contact with the skin, eyes and clothing. Do not breathe vapour/spray. Take off immediately all contaminated clothing. Store work clothing separately. Hands and/or face should be washed before breaks and at the end of the shift. No eating, drinking, smoking or tobacco use at the place of work. Gloves must be inspected regularly and prior to each use. Replace if necessary (e.g. pinhole leaks).

## SECTION 9: Physical and Chemical Properties

### 9.1. Information on basic physical and chemical properties

Form:	liquid	
Colour:	colourless to yellow	
Odour:	amine-like	
Odour threshold:	Not determined since harmful by inhalation.	
pH value:	10 (100 g/l, 20 °C)	
Melting point:	3 °C	(OECD Guideline 102)
Boiling point:	298 °C The substance / product decomposes.	
Flash point:	157.5 °C	(ISO 2719)

BASF Safety data sheet according to Regulation UK SI 2019/758 and UK SI 2020/1577 as amended from time to time.

Date / Revised: 15.12.2022

Version: 11.0

Date previous version: 29.03.2022

Previous version: 10.0

Date / First version: 08.08.2002

Product: **Baxxodur® EC 280**

(ID no. 30340659/SDS\_GEN\_GB/EN)

Date of print 26.02.2024

Evaporation rate:	Value can be approximated from Henry's Law Constant or vapor pressure.	
Flammability:	hardly combustible	(derived from flash point)
Lower explosion limit:	For liquids not relevant for classification and labelling., The lower explosion point may be 5 - 15 °C below the flash point.	
Upper explosion limit:	For liquids not relevant for classification and labelling.	
Ignition temperature:	274 °C	(DIN EN 14522)
Vapour pressure:	0.0011 hPa (25 °C)	(OECD Guideline 104)
	0.011 hPa (50 °C)	(Directive 84/449/EEC, A.4)
Density:	0.956 g/cm <sup>3</sup> (20 °C)	
Relative density:	0.9556 (20 °C, 1,013 hPa)	(OECD Guideline 109)
Relative vapour density (air):	> 1 (20 °C) Heavier than air.	(estimated)
Solubility in water:	miscible (23 °C)	(OECD Guideline 105)
Partitioning coefficient n-octanol/water (log Kow):	-0.4 (25 °C; pH value: 11.2)	(OECD Guideline 107)
Self ignition:	not self-igniting	Test type: Spontaneous self-ignition at room-temperature.
Thermal decomposition:	350 °C, > 380 kJ/kg, (DSC (OECD 113)) Thermal decomposition above the indicated temperature is possible.	
Viscosity, dynamic:	11.2 mPa.s (20 °C)	(calculated (from kinematic viscosity))
	5.61 mPa.s (40 °C)	(calculated (from kinematic viscosity))
Viscosity, kinematic:	11.7 mm <sup>2</sup> /s (20 °C)	(OECD 114)
	5.98 mm <sup>2</sup> /s (40 °C)	(OECD 114)
Explosion hazard:	Based on the chemical structure there is no indication of explosive properties.	
Fire promoting properties:	Based on its structural properties the product is not classified as oxidizing.	

## 9.2. Other information

BASF Safety data sheet according to Regulation UK SI 2019/758 and UK SI 2020/1577 as amended from time to time.

Date / Revised: 15.12.2022

Version: 11.0

Date previous version: 29.03.2022

Previous version: 10.0

Date / First version: 08.08.2002

Product: **Baxxodur® EC 280**

(ID no. 30340659/SDS\_GEN\_GB/EN)

Date of print 26.02.2024

Self heating ability:	not applicable, the product is a liquid	
SADT:	Not a substance liable to self-decomposition according to UN transport regulations, class 4.1.	
pKA:	10.3 (20 °C)	(OECD Guideline 112)
Adsorption/water - soil:	KOC: 30; log KOC: 1.48 Adsorption to solid soil phase is not expected. The data refer to the charged form of the substance.	(calculated)
Surface tension:	Based on chemical structure, surface activity is not to be expected.	
Grain size distribution:	The substance / product is marketed or used in a non solid or granular form.	
Molar mass:	204.31 g/mol	

## SECTION 10: Stability and Reactivity

### 10.1. Reactivity

No hazardous reactions if stored and handled as prescribed/indicated.

Corrosion to metals:	Corrosive effects to metal are not anticipated.	
Formation of flammable gases:	Remarks:	Forms no flammable gases in the presence of water.

### 10.2. Chemical stability

The product is stable if stored and handled as prescribed/indicated.

### 10.3. Possibility of hazardous reactions

Strong exothermic reaction with acids.

### 10.4. Conditions to avoid

Avoid all sources of ignition: heat, sparks, open flame.

### 10.5. Incompatible materials

Substances to avoid:  
Copper, strong acids, oxidizing agents, brass, metal alloys, copper alloys

### 10.6. Hazardous decomposition products

Possible thermal decomposition products:  
At prolonged and/or strong thermal stressing above the decomposition temperature dangerous decomposition products can be formed., Incomplete combustion results in formation of toxic gases, containing mainly carbon monoxide and carbon dioxide.

BASF Safety data sheet according to Regulation UK SI 2019/758 and UK SI 2020/1577 as amended from time to time.

Date / Revised: 15.12.2022

Version: 11.0

Date previous version: 29.03.2022

Previous version: 10.0

Date / First version: 08.08.2002

Product: **Baxxodur® EC 280**

(ID no. 30340659/SDS\_GEN\_GB/EN)

Date of print 26.02.2024

## SECTION 11: Toxicological Information

### 11.1. Information on toxicological effects

#### Acute toxicity

Assessment of acute toxicity:

Of moderate toxicity after short-term inhalation. Of low toxicity after single ingestion. Of low toxicity after short-term skin contact.

Experimental/calculated data:

LD50 rat (oral): approx. 3,450 mg/kg (similar to OECD guideline 401)

LC50 rat (by inhalation): 1.5 mg/l 4 h (similar to OECD guideline 403)

An aerosol was tested.

LD50 rat (dermal): > 1,000 mg/kg (OECD Guideline 402)

Due to the corrosive properties of the substance higher doses cannot be tested.

#### Irritation

Assessment of irritating effects:

Corrosive! Damages skin and eyes.

Experimental/calculated data:

Skin corrosion/irritation

rabbit: Corrosive. (similar to OECD guideline 404)

Serious eye damage/irritation

rabbit: irreversible damage (similar to OECD guideline 405)

#### Respiratory/Skin sensitization

Assessment of sensitization:

As the substance is corrosive, conducting sensitization studies is not feasible. The chemical structure suggests a sensitizing effect.

Experimental/calculated data:

in silico: skin sensitizing ((Q)SAR Model)

The product has not been tested. The statement has been derived from the structure of the product.

#### Germ cell mutagenicity

Assessment of mutagenicity:

The substance was not mutagenic in bacteria. The substance was not mutagenic in mammalian cell culture. The product has not been fully tested. The statements have been derived in parts from products of a similar structure or composition.

#### Carcinogenicity

---

BASF Safety data sheet according to Regulation UK SI 2019/758 and UK SI 2020/1577 as amended from time to time.

Date / Revised: 15.12.2022

Version: 11.0

Date previous version: 29.03.2022

Previous version: 10.0

Date / First version: 08.08.2002

Product: **Baxxodur® EC 280**

(ID no. 30340659/SDS\_GEN\_GB/EN)

Date of print 26.02.2024

---

#### Assessment of carcinogenicity:

No data available concerning carcinogenic effects. The whole of the information assessable provides no indication of a carcinogenic effect.

#### Reproductive toxicity

##### Assessment of reproduction toxicity:

The results of animal studies gave no indication of a fertility impairing effect. The results were determined in a Screening test (OECD 421/422). The product has not been tested. The statement has been derived from substances/products of a similar structure or composition.

#### Developmental toxicity

##### Assessment of teratogenicity:

No indications of a developmental toxic / teratogenic effect were seen in animal studies. The results were determined in a Screening test (OECD 421/422). The product has not been tested. The statement has been derived from substances/products of a similar structure or composition.

#### Specific target organ toxicity (single exposure)

##### Assessment of STOT single:

Based on the available information there is no specific target organ toxicity to be expected after a single exposure.

#### Repeated dose toxicity and Specific target organ toxicity (repeated exposure)

##### Assessment of repeated dose toxicity:

After repeated exposure the prominent effect is local irritation. The product has not been tested. The statement has been derived from substances/products of a similar structure or composition.

#### Aspiration hazard

not applicable

---

## SECTION 12: Ecological Information

### 12.1. Toxicity

#### Assessment of aquatic toxicity:

There is a high probability that the product is not acutely harmful to aquatic organisms. The inhibition of the degradation activity of activated sludge is not anticipated when introduced to biological treatment plants in appropriate low concentrations.

#### Toxicity to fish:

LC50 (96 h) > 464 mg/l, *Leuciscus idus* (DIN 38412 Part 15, static)

Nominal concentration. The product will cause changes in the pH value of the test system. The result refers to a neutralized sample.

---

BASF Safety data sheet according to Regulation UK SI 2019/758 and UK SI 2020/1577 as amended from time to time.

Date / Revised: 15.12.2022

Version: 11.0

Date previous version: 29.03.2022

Previous version: 10.0

Date / First version: 08.08.2002

Product: **Baxxodur® EC 280**

(ID no. 30340659/SDS\_GEN\_GB/EN)

Date of print 26.02.2024

---

#### Aquatic invertebrates:

EC50 (48 h) 218.16 mg/l, *Daphnia magna* (Directive 92/69/EEC, C.2, static)

Nominal concentration. The product has not been tested. The statement has been derived from substances/products of a similar structure or composition.

#### Aquatic plants:

EC50 (72 h) > 500 mg/l (growth rate), *Desmodium subspicatus* (DIN 38412 Part 9, static)

Nominal concentration. The product has not been tested. The statement has been derived from substances/products of a similar structure or composition.

EC10 (72 h) 31.3 mg/l (growth rate), *Desmodium subspicatus* (DIN 38412 Part 9, static)

Nominal concentration. The product has not been tested. The statement has been derived from substances/products of a similar structure or composition.

#### Microorganisms/Effect on activated sludge:

EC50 (17 h) 136 mg/l, *Pseudomonas putida* (DIN 38412 Part 8)

Nominal concentration. After neutralization no appreciable reduction in harmful effect can be observed.

#### Chronic toxicity to fish:

No data available.

#### Chronic toxicity to aquatic invertebrates:

No data available.

#### Assessment of terrestrial toxicity:

No data available.

## 12.2. Persistence and degradability

#### Assessment biodegradation and elimination (H<sub>2</sub>O):

Not readily biodegradable (by OECD criteria). The product has not been tested. The statement has been derived from substances/products of a similar structure or composition.

#### Elimination information:

0 % CO<sub>2</sub> formation relative to the theoretical value (60 d) (OECD 301B; ISO 9439; 92/69/EEC, C.4-C) (aerobic, activated sludge, domestic, non-adapted)

The product has not been tested. The statement has been derived from substances/products of a similar structure or composition.

#### Assessment of stability in water:

According to structural properties, hydrolysis is not expected/probable.

#### Information on Stability in Water (Hydrolysis):

According to structural properties, hydrolysis is not expected/probable.

## 12.3. Bioaccumulative potential

#### Assessment bioaccumulation potential:

---

BASF Safety data sheet according to Regulation UK SI 2019/758 and UK SI 2020/1577 as amended from time to time.

Date / Revised: 15.12.2022

Version: 11.0

Date previous version: 29.03.2022

Previous version: 10.0

Date / First version: 08.08.2002

Product: **Baxxodur® EC 280**

(ID no. 30340659/SDS\_GEN\_GB/EN)

Date of print 26.02.2024

---

Because of the n-octanol/water distribution coefficient (log Pow) accumulation in organisms is not to be expected.

#### **12.4. Mobility in soil**

Assessment transport between environmental compartments:

Volatility: The substance will not evaporate into the atmosphere from the water surface. The data refer to the charged form of the substance.

Adsorption in soil: Adsorption to solid soil phase is not expected. The product has not been tested. The statement has been derived from the structure of the product. The data refer to the charged form of the substance.

#### **12.5. Results of PBT and vPvB assessment**

According to Annex XIII of Regulation (EC) No.1907/2006 concerning the Registration, Evaluation, Authorisation and Restriction of Chemicals (REACH): The product does not fulfill the criteria for PBT (Persistent/bioaccumulative/toxic) and vPvB (very persistent/very bioaccumulative). Self classification

#### **12.6. Other adverse effects**

The substance is not listed in Regulation (EC) 1005/2009 on substances that deplete the ozone layer.

#### **12.7. Additional information**

Sum parameter

Chemical oxygen demand (COD): 1,690 mg/l

Biochemical oxygen demand (BOD) Incubation period 5 d: 115 mg/l

Adsorbable organically-bound halogen (AOX):  
This product contains no organically-bound halogen.

Other ecotoxicological advice:

Due to the pH-value of the product, neutralization is generally required before discharging sewage into treatment plants.

---

## **SECTION 13: Disposal Considerations**

### **13.1. Waste treatment methods**

Incinerate in suitable incineration plant, observing local authority regulations.

A waste code in accordance with the European waste catalog (EWC) cannot be specified, due to dependence on the usage.

---

BASF Safety data sheet according to Regulation UK SI 2019/758 and UK SI 2020/1577 as amended from time to time.

Date / Revised: 15.12.2022

Version: 11.0

Date previous version: 29.03.2022

Previous version: 10.0

Date / First version: 08.08.2002

Product: **Baxxodur® EC 280**

(ID no. 30340659/SDS\_GEN\_GB/EN)

Date of print 26.02.2024

---

The waste code in accordance with the European waste catalog (EWC) must be specified in cooperation with disposal agency/manufacturer/authorities.

The UK Environmental Protection (Duty of Care) Regulations (EP) and amendments should be noted (United Kingdom).

This product and any uncleaned containers must be disposed of as hazardous waste in accordance with the 2005 Hazardous Waste Regulations and amendments (United Kingdom)

Contaminated packaging:

Contaminated packaging should be emptied as far as possible; then it can be passed on for recycling after being thoroughly cleaned.

---

## SECTION 14: Transport Information

### Land transport

ADR

UN number or ID number: UN2735  
UN proper shipping name: AMINES, LIQUID, CORROSIVE, N.O.S. (contains 4,9-DIOXADODECANE-1,12-DIAMINE)  
Transport hazard class(es): 8  
Packing group: II  
Environmental hazards: no  
Special precautions for user: Tunnel code: E

RID

UN number or ID number: UN2735  
UN proper shipping name: AMINES, LIQUID, CORROSIVE, N.O.S. (contains 4,9-DIOXADODECANE-1,12-DIAMINE)  
Transport hazard class(es): 8  
Packing group: II  
Environmental hazards: no  
Special precautions for user: None known

### Inland waterway transport

ADN

UN number or ID number: UN2735  
UN proper shipping name: AMINES, LIQUID, CORROSIVE, N.O.S. (contains 4,9-DIOXADODECANE-1,12-DIAMINE)  
Transport hazard class(es): 8  
Packing group: II  
Environmental hazards: no

BASF Safety data sheet according to Regulation UK SI 2019/758 and UK SI 2020/1577 as amended from time to time.

Date / Revised: 15.12.2022

Version: 11.0

Date previous version: 29.03.2022

Previous version: 10.0

Date / First version: 08.08.2002

Product: **Baxxodur® EC 280**

(ID no. 30340659/SDS\_GEN\_GB/EN)

Date of print 26.02.2024

Special precautions for user:           None known

Transport in inland waterway vessel

Not evaluated

**Sea transport**

IMDG

UN number or ID number: UN 2735

UN proper shipping name: AMINES, LIQUID, CORROSIVE, N.O.S. (contains 4,9-DIOXADODECANE-1,12-DIAMINE)

Transport hazard class(es): 8

Packing group: II

Environmental hazards: no

Marine pollutant: NO

Special precautions for user:

**Air transport**

IATA/ICAO

UN number or ID number: UN 2735

UN proper shipping name: AMINES, LIQUID, CORROSIVE, N.O.S. (contains 4,9-DIOXADODECANE-1,12-DIAMINE)

Transport hazard class(es): 8

Packing group: II

Environmental hazards: No Mark as dangerous for the environment is needed

Special precautions for user:           None known

**14.1. UN number or ID number**

See corresponding entries for "UN number or ID number" for the respective regulations in the tables above.

**14.2. UN proper shipping name**

See corresponding entries for "UN proper shipping name" for the respective regulations in the tables above.

**14.3. Transport hazard class(es)**

See corresponding entries for "Transport hazard class(es)" for the respective regulations in the tables above.

---

BASF Safety data sheet according to Regulation UK SI 2019/758 and UK SI 2020/1577 as amended from time to time.

Date / Revised: 15.12.2022

Version: 11.0

Date previous version: 29.03.2022

Previous version: 10.0

Date / First version: 08.08.2002

Product: **Baxxodur® EC 280**

(ID no. 30340659/SDS\_GEN\_GB/EN)

Date of print 26.02.2024

---

#### **14.4. Packing group**

See corresponding entries for "Packing group" for the respective regulations in the tables above.

#### **14.5. Environmental hazards**

See corresponding entries for "Environmental hazards" for the respective regulations in the tables above.

#### **14.6. Special precautions for user**

See corresponding entries for "Special precautions for user" for the respective regulations in the tables above.

#### **14.7. Maritime transport in bulk according to IMO instruments**

Maritime transport in bulk is not intended.

#### **Further information**

This product is subject to the most recent edition of "The Carriage of Dangerous Goods and Use of Transportable Pressure Equipment Regulations" and their amendments (United Kingdom).

---

### **SECTION 15: Regulatory Information**

#### **15.1. Safety, health and environmental regulations/legislation specific for the substance or mixture**

##### Prohibitions, Restrictions and Authorizations

Annex XVII of Regulation (EC) No 1907/2006: Number on List: 3

Directive 2012/18/EU - Control of Major Accident Hazards involving dangerous substances (EU):  
Listed in above regulation: no

If other regulatory information applies that is not already provided elsewhere in this safety data sheet, then it is described in this subsection.

The data should be considered when making any assessment under the Control of Substances Hazardous to Health Regulations (COSHH), and related guidance, for example, 'COSHH Essentials' (United Kingdom).

#### **15.2. Chemical Safety Assessment**

Chemical Safety Assessment performed

---

### **SECTION 16: Other Information**

Assessment of the hazard classes according to UN GHS criteria (most recent version)

BASF Safety data sheet according to Regulation UK SI 2019/758 and UK SI 2020/1577 as amended from time to time.

Date / Revised: 15.12.2022

Version: 11.0

Date previous version: 29.03.2022

Previous version: 10.0

Date / First version: 08.08.2002

Product: **Baxxodur® EC 280**

(ID no. 30340659/SDS\_GEN\_GB/EN)

Date of print 26.02.2024

Acute Tox. 5 (oral)  
 Acute Tox. 5 (dermal)  
 Acute Tox. 4 (Inhalation - mist)  
 Skin Corr./Irrit. 1B  
 Skin Sens. 1  
 Eye Dam./Irrit. 1

Any other intended applications should be discussed with the manufacturer. Corresponding occupational protection measurements must be followed.

Full text of the classifications, including the hazard classes and the hazard statements, if mentioned in section 2 or 3:

Acute Tox.	Acute toxicity
Skin Corr./Irrit.	Skin corrosion/irritation
Eye Dam./Irrit.	Serious eye damage/eye irritation
Skin Sens.	Skin sensitization
H332	Harmful if inhaled.
H317	May cause an allergic skin reaction.
H314	Causes severe skin burns and eye damage.

#### Abbreviations

ADR = The European Agreement concerning the International Carriage of Dangerous Goods by Road.  
 ADN = The European Agreement concerning the International Carriage of Dangerous Goods by Inland waterways. ATE = Acute Toxicity Estimates. CAO = Cargo Aircraft Only. CAS = Chemical Abstract Service. CLP = Classification, Labelling and Packaging of substances and mixtures. DIN = German national organization for standardization. DNEL = Derived No Effect Level. EC50 = Effective concentration median for 50% of the population. EC = European Community. EN = European Standards. IARC = International Agency for Research on Cancer. IATA = International Air Transport Association. IBC-Code = Intermediate Bulk Container code. IMDG = International Maritime Dangerous Goods Code. ISO = International Organization for Standardization. STEL = Short-Term Exposure Limit. LC50 = Lethal concentration median for 50% of the population. LD50 = Lethal dose median for 50% of the population. TLV = Threshold Limit Value. MARPOL = The International Convention for the Prevention of Pollution from Ships. NEN = Dutch Norm. NOEC = No Observed Effect Concentration. OEL = Occupational Exposure Limit. OECD = Organization for Economic Cooperation and Development. PBT = Persistent, Bioaccumulative and Toxic. PNEC = Predicted No Effect Level. PPM = Parts per million. RID = The European Agreement concerning the International Carriage of Dangerous Goods by Rail. TWA = Time Weight Average. UN-number = UN number at transport. vPvB = very Persistent and very Bioaccumulative.

The data contained in this safety data sheet are based on our current knowledge and experience and describe the product only with regard to safety requirements. This safety data sheet is neither a Certificate of Analysis (CoA) nor technical data sheet and shall not be mistaken for a specification agreement. Identified uses in this safety data sheet do neither represent an agreement on the corresponding contractual quality of the substance/mixture nor a contractually designated use. It is the responsibility of the recipient of the product to ensure any proprietary rights and existing laws and legislation are observed.

Vertical lines in the left hand margin indicate an amendment from the previous version.

BASF Safety data sheet according to Regulation UK SI 2019/758 and UK SI 2020/1577 as amended from time to time.

Date / Revised: 15.12.2022

Version: 11.0

Date previous version: 29.03.2022

Previous version: 10.0

Date / First version: 08.08.2002

Product: **Baxxodur® EC 280**

(ID no. 30340659/SDS\_GEN\_GB/EN)

Date of print 26.02.2024

## Annex: Exposure Scenarios

### Index

1. Charging and discharging of substances and mixtures  
SU3; ERC2; PROC8a, PROC8b, PROC9
2. Charging and discharging of substances and mixtures  
SU22; ERC8a; PROC8a, PROC8b, PROC9
3. Formulation  
SU3; ERC2; PROC1, PROC2, PROC3, PROC4, PROC5
4. Formulation  
SU22; ERC8a, ERC8c, ERC8f; PROC1, PROC2, PROC3, PROC4, PROC5
5. Use in laboratories  
SU3; ERC4; PROC15
6. Use in laboratories  
SU22; ERC8a; PROC15
7. Use as a Process chemical  
SU3; ERC4; PROC1, PROC2, PROC3, PROC4
8. Use as an intermediate  
SU3; ERC6a; PROC1, PROC2, PROC3
9. Polymer production, Use as a Process chemical  
SU3; ERC6d; PROC1, PROC2, PROC3, PROC4, PROC5, PROC7, PROC10, PROC13
10. Polymer production, Use as a Process chemical  
SU22; ERC8c, ERC8f; PROC10, PROC11, PROC13, PROC14, PROC19

\*\*\*\*\*

### 1. Short title of exposure scenario

Charging and discharging of substances and mixtures  
SU3; ERC2; PROC8a, PROC8b, PROC9

### Control of exposure and risk management measures

<b>Contributing exposure scenario</b>	
<b>Use descriptors covered</b>	ERC2: Formulation into mixture
<b>Operational conditions</b>	
Annual amount used in the EU	120,000 kg
Minimum emission days per year	100

BASF Safety data sheet according to Regulation UK SI 2019/758 and UK SI 2020/1577 as amended from time to time.

Date / Revised: 15.12.2022

Version: 11.0

Date previous version: 29.03.2022

Previous version: 10.0

Date / First version: 08.08.2002

Product: **Baxxodur® EC 280**

(ID no. 30340659/SDS\_GEN\_GB/EN)

Date of print 26.02.2024

Emission factor air	0.001 %
Emission factor water	0.001 %
Emission factor soil	0 %
Receive Surf. Water (Flow Rate).	18,000 m <sup>3</sup> /d
Dilution factor river	10
Dilution factor coast	100
<b>Risk Management Measures</b>	
Air treatment measures considered suitable are, e.g.	Exhaust air scrubber, Waste gas treatment by thermal oxidation
Wastewater treatment measures considered suitable are, e.g.	Aerobic biological treatment
Soil treatment measures considered suitable are, e.g.	No application of sludge to soil, Sealing of all relevant soil surfaces, Sewage Sludge incineration
	No application of sludge to soil
Type of STP	Municipal STP
Assumed sewage treatment plant flow (m <sup>3</sup> /d)	2,000 m <sup>3</sup> /d
<b>Exposure estimate and reference to its source</b>	
Assessment method	EASY TRA v4.2, ECETOC TRA v3.0, Environment
Risk Characterization Ratio (RCR)	0.003698
	Risk from environmental exposure is driven by marine water.
Maximum amount of safe use	324,516.4 kg/d
Risk from environmental exposure is driven by marine water.	

<b>Contributing exposure scenario</b>	
<b>Use descriptors covered</b>	PROC8a: Transfer of substance or mixture (charging and discharging) at non-dedicated facilities Use domain: industrial
<b>Operational conditions</b>	
Concentration of the substance	3,3'-[Butane-1,4-diylbis(oxy)]bispropanamine Content: >= 0 % - <= 100 %
Physical state	liquid
Vapour pressure of the substance during use	0.067 Pa
	Air concentration is limited to the saturated air concentration of the pure compound.

BASF Safety data sheet according to Regulation UK SI 2019/758 and UK SI 2020/1577 as amended from time to time.

Date / Revised: 15.12.2022

Version: 11.0

Date previous version: 29.03.2022

Previous version: 10.0

Date / First version: 08.08.2002

Product: **Baxxodur® EC 280**

(ID no. 30340659/SDS\_GEN\_GB/EN)

Date of print 26.02.2024

Duration and Frequency of activity	480 min 5 days per week
Indoor/Outdoor	Indoor
	Assumes activities are at ambient temperature.
<b>Risk Management Measures</b>	
Local exhaust ventilation	Effectiveness: 90 %
Wear chemically resistant gloves in combination with specific activity training	Effectiveness: 95 %
Provide a good standard of general ventilation (not less than 3 - 5 air changes per hour)	Effectiveness: 30 %
Avoid frequent and direct contact with substance. Supervision in place to check that the RMMs in place are being used correctly and OCs followed. Clean equipment and the work area every day. Ensure minimization of manual phases	
Use suitable chemically resistant gloves., Wear suitable working clothes., Change gloves, if duration of activity exceeds break through time	
Use suitable eye protection.	
<b>Exposure estimate and reference to its source</b>	
Assessment method	EASY TRA v4.2, ECETOC TRA v3.0, Worker
	Worker - dermal, long-term - systemic
Exposure estimate	0.6857 mg/kg bw/day
Risk Characterization Ratio (RCR)	0.082616
Assessment method	EASY TRA v4.2, ECETOC TRA v3.0, Worker
	Worker - inhalation, long-term - local
Exposure estimate	0.5525 mg/m <sup>3</sup>
Risk Characterization Ratio (RCR)	0.552519
<b>Guidance to Downstream Users</b>	
For scaling see: <a href="http://www.ecetoc.org/tra">http://www.ecetoc.org/tra</a>	

<b>Contributing exposure scenario</b>	
<b>Use descriptors covered</b>	PROC8a: Transfer of substance or mixture (charging and discharging) at non-dedicated facilities Use domain: industrial
<b>Operational conditions</b>	
Concentration of the substance	3,3'-[Butane-1,4-diylbis(oxy)]bispropanamine Content: >= 0 % - <= 100 %
Physical state	liquid
Vapour pressure of the substance during use	0.067 Pa
Process temperature	20 °C

BASF Safety data sheet according to Regulation UK SI 2019/758 and UK SI 2020/1577 as amended from time to time.

Date / Revised: 15.12.2022

Version: 11.0

Date previous version: 29.03.2022

Previous version: 10.0

Date / First version: 08.08.2002

Product: **Baxxodur® EC 280**

(ID no. 30340659/SDS\_GEN\_GB/EN)

Date of print 26.02.2024

Duration and Frequency of activity	15 min 5 days per week
Indoor/Outdoor	Outdoor
<b>Risk Management Measures</b>	
Wear chemically resistant gloves in combination with specific activity training	Effectiveness: 95 %
Avoid frequent and direct contact with substance. Supervision in place to check that the RMMs in place are being used correctly and OCs followed. Clean equipment and the work area every day. Ensure minimization of manual phases	
Use suitable chemically resistant gloves., Wear suitable working clothes., Change gloves, if duration of activity exceeds break through time	
Use suitable eye protection.	
<b>Exposure estimate and reference to its source</b>	
Assessment method	EASY TRA v3.5, ECETOC TRA v3.0, Worker
	Worker - dermal, long-term - systemic
Exposure estimate	0.6857 mg/kg bw/day
Risk Characterization Ratio (RCR)	0.082616
Assessment method	EASY TRA v3.5, ECETOC TRA v3.0, worker, modified version
	Worker - inhalation, long-term - local
Exposure estimate	0.5959 mg/m <sup>3</sup>
Risk Characterization Ratio (RCR)	0.595904
<b>Guidance to Downstream Users</b>	
For scaling see: <a href="http://www.ecetoc.org/tra">http://www.ecetoc.org/tra</a> Please note that a modified version has been used (see exposure estimates)	

<b>Contributing exposure scenario</b>	
<b>Use descriptors covered</b>	PROC8b: Transfer of substance or mixture (charging and discharging) at dedicated facilities Use domain: industrial
<b>Operational conditions</b>	
Concentration of the substance	3,3'-[Butane-1,4-diylbis(oxy)]bispropanamine Content: >= 0 % - <= 100 %
Physical state	liquid
Vapour pressure of the substance during use	0.067 Pa
Process temperature	20 °C
Duration and Frequency of activity	15 min 5 days per week

BASF Safety data sheet according to Regulation UK SI 2019/758 and UK SI 2020/1577 as amended from time to time.

Date / Revised: 15.12.2022

Version: 11.0

Date previous version: 29.03.2022

Previous version: 10.0

Date / First version: 08.08.2002

Product: **Baxxodur® EC 280**

(ID no. 30340659/SDS\_GEN\_GB/EN)

Date of print 26.02.2024

Indoor/Outdoor	Outdoor
<b>Risk Management Measures</b>	
Wear chemically resistant gloves in combination with specific activity training	Effectiveness: 95 %
Avoid frequent and direct contact with substance. Supervision in place to check that the RMMs in place are being used correctly and OCs followed. Clean equipment and the work area every day. Ensure minimization of manual phases	
Use suitable chemically resistant gloves., Wear suitable working clothes., Change gloves, if duration of activity exceeds break through time	
Use suitable eye protection.	
<b>Exposure estimate and reference to its source</b>	
Assessment method	EASY TRA v3.5, ECETOC TRA v3.0, worker, modified version, The duration of activity has been considered using a linear approach.
	Worker - dermal, long-term - systemic
Exposure estimate	0.0214 mg/kg bw/day
Risk Characterization Ratio (RCR)	0.002582
Assessment method	EASY TRA v3.5, ECETOC TRA v3.0, worker, modified version, The duration of activity has been considered using a linear approach.
	Worker - inhalation, long-term - local
Exposure estimate	0.9311 mg/m <sup>3</sup>
Risk Characterization Ratio (RCR)	0.931099
<b>Guidance to Downstream Users</b>	
For scaling see: <a href="http://www.ecetoc.org/tra">http://www.ecetoc.org/tra</a> Please note that a modified version has been used (see exposure estimates)	

<b>Contributing exposure scenario</b>	
<b>Use descriptors covered</b>	PROC8b: Transfer of substance or mixture (charging and discharging) at dedicated facilities Use domain: industrial
<b>Operational conditions</b>	
Concentration of the substance	3,3'-[Butane-1,4-diylbis(oxy)]bispropanamine Content: >= 0 % - <= 100 %
Physical state	liquid
Vapour pressure of the substance during use	0.067 Pa
Process temperature	20 °C

BASF Safety data sheet according to Regulation UK SI 2019/758 and UK SI 2020/1577 as amended from time to time.

Date / Revised: 15.12.2022

Version: 11.0

Date previous version: 29.03.2022

Previous version: 10.0

Date / First version: 08.08.2002

Product: **Baxxodur® EC 280**

(ID no. 30340659/SDS\_GEN\_GB/EN)

Date of print 26.02.2024

Duration and Frequency of activity	480 min 5 days per week
Indoor/Outdoor	Indoor
<b>Risk Management Measures</b>	
Wear chemically resistant gloves in combination with specific activity training	Effectiveness: 95 %
Avoid frequent and direct contact with substance. Supervision in place to check that the RMMs in place are being used correctly and OCs followed. Clean equipment and the work area every day. Ensure minimization of manual phases	
Use suitable chemically resistant gloves., Wear suitable working clothes., Change gloves, if duration of activity exceeds break through time	
Use suitable eye protection.	
<b>Exposure estimate and reference to its source</b>	
Assessment method	EASY TRA v3.5, ECETOC TRA v3.0, Worker
	Worker - dermal, long-term - systemic
Exposure estimate	0.6857 mg/kg bw/day
Risk Characterization Ratio (RCR)	0.082616
Assessment method	EASY TRA v3.5, ECETOC TRA v3.0, worker, modified version
	Worker - inhalation, long-term - local
Exposure estimate	0.0001 mg/m <sup>3</sup>
Risk Characterization Ratio (RCR)	0.000001
<b>Guidance to Downstream Users</b>	
For scaling see: <a href="http://www.ecetoc.org/tra">http://www.ecetoc.org/tra</a> Please note that a modified version has been used (see exposure estimates)	

<b>Contributing exposure scenario</b>	
<b>Use descriptors covered</b>	PROC8b: Transfer of substance or mixture (charging and discharging) at dedicated facilities Use domain: industrial
<b>Operational conditions</b>	
Concentration of the substance	3,3'-[Butane-1,4-diylbis(oxy)]bispropanamine Content: >= 0 % - <= 100 %
Physical state	liquid
Vapour pressure of the substance during use	0.067 Pa
	Air concentration is limited to the saturated air concentration of the pure compound.
Duration and Frequency of activity	480 min 5 days per week

BASF Safety data sheet according to Regulation UK SI 2019/758 and UK SI 2020/1577 as amended from time to time.

Date / Revised: 15.12.2022

Version: 11.0

Date previous version: 29.03.2022

Previous version: 10.0

Date / First version: 08.08.2002

Product: **Baxxodur® EC 280**

(ID no. 30340659/SDS\_GEN\_GB/EN)

Date of print 26.02.2024

Indoor/Outdoor	Indoor
	Assumes activities are at ambient temperature.
<b>Risk Management Measures</b>	
Local exhaust ventilation	Effectiveness: 95 %
Wear chemically resistant gloves in combination with specific activity training	Effectiveness: 95 %
Provide a good standard of general ventilation (not less than 3 - 5 air changes per hour)	Effectiveness: 30 %
Avoid frequent and direct contact with substance. Supervision in place to check that the RMMs in place are being used correctly and OCs followed. Clean equipment and the work area every day. Ensure minimization of manual phases	
Use suitable chemically resistant gloves., Wear suitable working clothes., Change gloves, if duration of activity exceeds break through time	
Use suitable eye protection.	
<b>Exposure estimate and reference to its source</b>	
Assessment method	EASY TRA v4.2, ECETOC TRA v3.0, Worker
	Worker - dermal, long-term - systemic
Exposure estimate	0.6857 mg/kg bw/day
Risk Characterization Ratio (RCR)	0.082616
Assessment method	EASY TRA v4.2, ECETOC TRA v3.0, Worker
	Worker - inhalation, long-term - local
Exposure estimate	0.2763 mg/m <sup>3</sup>
Risk Characterization Ratio (RCR)	0.276259
<b>Guidance to Downstream Users</b>	
For scaling see: <a href="http://www.ecetoc.org/tra">http://www.ecetoc.org/tra</a>	

<b>Contributing exposure scenario</b>	
<b>Use descriptors covered</b>	PROC9: Transfer of substance or preparation into small containers (dedicated filling line, including weighing). Use domain: industrial
<b>Operational conditions</b>	
Concentration of the substance	3,3'-[Butane-1,4-diylbis(oxy)]bispropanamine Content: >= 0 % - <= 100 %
Physical state	liquid
Vapour pressure of the substance during use	0.067 Pa
Process temperature	20 °C
Duration and Frequency of activity	480 min 5 days per week

BASF Safety data sheet according to Regulation UK SI 2019/758 and UK SI 2020/1577 as amended from time to time.

Date / Revised: 15.12.2022

Version: 11.0

Date previous version: 29.03.2022

Previous version: 10.0

Date / First version: 08.08.2002

Product: **Baxxodur® EC 280**

(ID no. 30340659/SDS\_GEN\_GB/EN)

Date of print 26.02.2024

Indoor/Outdoor	Indoor
<b>Risk Management Measures</b>	
Local exhaust ventilation	Effectiveness: 90 %
Use suitable chemically resistant gloves.	Effectiveness: 80 %
Avoid frequent and direct contact with substance. Supervision in place to check that the RMMs in place are being used correctly and OCs followed. Clean equipment and the work area every day. Ensure minimization of manual phases	
Use suitable chemically resistant gloves., Wear suitable working clothes., Change gloves, if duration of activity exceeds break through time	
Use suitable eye protection.	
<b>Exposure estimate and reference to its source</b>	
Assessment method	EASY TRA v3.5, ECETOC TRA v3.0, Worker
	Worker - dermal, long-term - systemic
Exposure estimate	1.3714 mg/kg bw/day
Risk Characterization Ratio (RCR)	0.165232
Assessment method	EASY TRA v3.5, ECETOC TRA v3.0, worker, modified version
	Worker - inhalation, long-term - local
Exposure estimate	0.0001 mg/m <sup>3</sup>
Risk Characterization Ratio (RCR)	0.000001
<b>Guidance to Downstream Users</b>	
For scaling see: <a href="http://www.ecetoc.org/tra">http://www.ecetoc.org/tra</a> Please note that a modified version has been used (see exposure estimates)	

<b>Contributing exposure scenario</b>	
<b>Use descriptors covered</b>	PROC9: Transfer of substance or preparation into small containers (dedicated filling line, including weighing). Use domain: industrial
<b>Operational conditions</b>	
Concentration of the substance	3,3'-[Butane-1,4-diylbis(oxy)]bispropanamine Content: >= 0 % - <= 100 %
Physical state	liquid
Vapour pressure of the substance during use	0.067 Pa
	Air concentration is limited to the saturated air concentration of the pure compound.
Duration and Frequency of activity	480 min 5 days per week
Indoor/Outdoor	Indoor

BASF Safety data sheet according to Regulation UK SI 2019/758 and UK SI 2020/1577 as amended from time to time.

Date / Revised: 15.12.2022

Version: 11.0

Date previous version: 29.03.2022

Previous version: 10.0

Date / First version: 08.08.2002

Product: **Baxxodur® EC 280**

(ID no. 30340659/SDS\_GEN\_GB/EN)

Date of print 26.02.2024

	Assumes activities are at ambient temperature.
<b>Risk Management Measures</b>	
Local exhaust ventilation	Effectiveness: 90 %
Wear chemically resistant gloves in combination with specific activity training	Effectiveness: 95 %
Provide a good standard of general ventilation (not less than 3 - 5 air changes per hour)	Effectiveness: 30 %
Avoid frequent and direct contact with substance. Supervision in place to check that the RMMs in place are being used correctly and OCs followed. Clean equipment and the work area every day. Ensure minimization of manual phases	
Use suitable chemically resistant gloves., Wear suitable working clothes., Change gloves, if duration of activity exceeds break through time	
Use suitable eye protection.	
<b>Exposure estimate and reference to its source</b>	
Assessment method	EASY TRA v4.2, ECETOC TRA v3.0, Worker
	Worker - dermal, long-term - systemic
Exposure estimate	0.3429 mg/kg bw/day
Risk Characterization Ratio (RCR)	0.041308
Assessment method	EASY TRA v4.2, ECETOC TRA v3.0, Worker
	Worker - inhalation, long-term - local
Exposure estimate	0.5525 mg/m <sup>3</sup>
Risk Characterization Ratio (RCR)	0.552519
<b>Guidance to Downstream Users</b>	
For scaling see: <a href="http://www.ecetoc.org/tra">http://www.ecetoc.org/tra</a>	

<b>Contributing exposure scenario</b>	
<b>Use descriptors covered</b>	PROC9: Transfer of substance or preparation into small containers (dedicated filling line, including weighing). Use domain: industrial
<b>Operational conditions</b>	
Concentration of the substance	3,3'-[Butane-1,4-diylbis(oxy)]bispropanamine Content: >= 0 % - <= 100 %
Physical state	liquid
Vapour pressure of the substance during use	0.067 Pa
Process temperature	20 °C
Duration and Frequency of activity	60 min 5 days per week

BASF Safety data sheet according to Regulation UK SI 2019/758 and UK SI 2020/1577 as amended from time to time.

Date / Revised: 15.12.2022

Version: 11.0

Date previous version: 29.03.2022

Previous version: 10.0

Date / First version: 08.08.2002

Product: **Baxxodur® EC 280**

(ID no. 30340659/SDS\_GEN\_GB/EN)

Date of print 26.02.2024

Indoor/Outdoor	Outdoor
<b>Risk Management Measures</b>	
Wear chemically resistant gloves in combination with specific activity training	Effectiveness: 95 %
Avoid frequent and direct contact with substance. Supervision in place to check that the RMMs in place are being used correctly and OCs followed. Clean equipment and the work area every day. Ensure minimization of manual phases	
Use suitable chemically resistant gloves., Wear suitable working clothes., Change gloves, if duration of activity exceeds break through time	
Use suitable eye protection.	
<b>Exposure estimate and reference to its source</b>	
Assessment method	EASY TRA v3.5, ECETOC TRA v3.0, Worker
	Worker - dermal, long-term - systemic
Exposure estimate	0.3429 mg/kg bw/day
Risk Characterization Ratio (RCR)	0.041308
Assessment method	EASY TRA v3.5, ECETOC TRA v3.0, worker, modified version
	Worker - inhalation, long-term - local
Exposure estimate	0.5959 mg/m <sup>3</sup>
Risk Characterization Ratio (RCR)	0.595904
<b>Guidance to Downstream Users</b>	
For scaling see: <a href="http://www.ecetoc.org/tra">http://www.ecetoc.org/tra</a> Please note that a modified version has been used (see exposure estimates)	

\*\*\*\*\*

## 2. Short title of exposure scenario

Charging and discharging of substances and mixtures

SU22; ERC8a; PROC8a, PROC8b, PROC9

### Control of exposure and risk management measures

Contributing exposure scenario	
<b>Use descriptors covered</b>	ERC8a: Widespread use of non-reactive processing aid (no inclusion into or onto article, indoor) As no environmental hazard was identified no environmental-related exposure assessment and risk characterization was performed.
<b>Operational conditions</b>	

Contributing exposure scenario
--------------------------------

BASF Safety data sheet according to Regulation UK SI 2019/758 and UK SI 2020/1577 as amended from time to time.

Date / Revised: 15.12.2022

Version: 11.0

Date previous version: 29.03.2022

Previous version: 10.0

Date / First version: 08.08.2002

Product: **Baxxodur® EC 280**

(ID no. 30340659/SDS\_GEN\_GB/EN)

Date of print 26.02.2024

<b>Use descriptors covered</b>	PROC8a: Transfer of substance or mixture (charging and discharging) at non-dedicated facilities Use domain: professional
<b>Operational conditions</b>	
Concentration of the substance	3,3'-[Butane-1,4-diylbis(oxy)]bispropanamine Content: >= 0 % - <= 100 %
Physical state	liquid
Vapour pressure of the substance during use	0.067 Pa
Process temperature	20 °C
Duration and Frequency of activity	10 min 5 days per week
Indoor/Outdoor	Outdoor
<b>Risk Management Measures</b>	
Wear chemically resistant gloves in combination with 'basic' employee training.	Effectiveness: 90 %
Avoid frequent and direct contact with substance. Supervision in place to check that the RMMs in place are being used correctly and OCs followed. Clean equipment and the work area every day. Ensure minimization of manual phases	
Use suitable chemically resistant gloves., Wear suitable working clothes., Change gloves, if duration of activity exceeds break through time	
Use suitable eye protection.	
<b>Exposure estimate and reference to its source</b>	
Assessment method	EASY TRA v3.5, ECETOC TRA v3.0, worker, modified version, The duration of activity has been considered using a linear approach.
	Worker - dermal, long-term - systemic
Exposure estimate	0.0286 mg/kg bw/day
Risk Characterization Ratio (RCR)	0.003442
Assessment method	EASY TRA v3.5, ECETOC TRA v3.0, worker, modified version, The duration of activity has been considered using a linear approach.
	Worker - inhalation, long-term - local
Exposure estimate	0.3104 mg/m <sup>3</sup>
Risk Characterization Ratio (RCR)	0.310366
<b>Guidance to Downstream Users</b>	
For scaling see: <a href="http://www.ecetoc.org/tra">http://www.ecetoc.org/tra</a> Please note that a modified version has been used (see exposure estimates)	

BASF Safety data sheet according to Regulation UK SI 2019/758 and UK SI 2020/1577 as amended from time to time.

Date / Revised: 15.12.2022

Version: 11.0

Date previous version: 29.03.2022

Previous version: 10.0

Date / First version: 08.08.2002

Product: **Baxxodur® EC 280**

(ID no. 30340659/SDS\_GEN\_GB/EN)

Date of print 26.02.2024

<b>Contributing exposure scenario</b>	
<b>Use descriptors covered</b>	PROC8a: Transfer of substance or mixture (charging and discharging) at non-dedicated facilities Use domain: professional
<b>Operational conditions</b>	
Concentration of the substance	3,3'-[Butane-1,4-diylbis(oxy)]bispropanamine Content: >= 0 % - <= 100 %
Physical state	liquid
Vapour pressure of the substance during use	0.067 Pa
Process temperature	20 °C
Duration and Frequency of activity	10 min 5 days per week
Indoor/Outdoor	Indoor
<b>Risk Management Measures</b>	
Local exhaust ventilation	Effectiveness: 80 %
Wear chemically resistant gloves in combination with 'basic' employee training.	Effectiveness: 90 %
Avoid frequent and direct contact with substance. Supervision in place to check that the RMMs in place are being used correctly and OCs followed. Clean equipment and the work area every day. Ensure minimization of manual phases	
Use suitable chemically resistant gloves., Wear suitable working clothes., Change gloves, if duration of activity exceeds break through time	
Use suitable eye protection.	
<b>Exposure estimate and reference to its source</b>	
Assessment method	EASY TRA v3.5, ECETOC TRA v3.0, worker, modified version, The duration of activity has been considered using a linear approach.
	Worker - dermal, long-term - systemic
Exposure estimate	0.0286 mg/kg bw/day
Risk Characterization Ratio (RCR)	0.003442
Assessment method	EASY TRA v3.5, ECETOC TRA v3.0, worker, modified version, The duration of activity has been considered using a linear approach.
	Worker - inhalation, long-term - local
Exposure estimate	0.8868 mg/m <sup>3</sup>
Risk Characterization Ratio (RCR)	0.886761
<b>Guidance to Downstream Users</b>	
For scaling see: <a href="http://www.ecetoc.org/tra">http://www.ecetoc.org/tra</a> Please note that a modified version has been used (see	

BASF Safety data sheet according to Regulation UK SI 2019/758 and UK SI 2020/1577 as amended from time to time.

Date / Revised: 15.12.2022

Version: 11.0

Date previous version: 29.03.2022

Previous version: 10.0

Date / First version: 08.08.2002

Product: **Baxxodur® EC 280**

(ID no. 30340659/SDS\_GEN\_GB/EN)

Date of print 26.02.2024

exposure estimates)

<b>Contributing exposure scenario</b>	
<b>Use descriptors covered</b>	PROC8b: Transfer of substance or mixture (charging and discharging) at dedicated facilities Use domain: professional
<b>Operational conditions</b>	
Concentration of the substance	3,3'-[Butane-1,4-diylbis(oxy)]bispropanamine Content: >= 0 % - <= 100 %
Physical state	liquid
Vapour pressure of the substance during use	0.067 Pa
Process temperature	20 °C
Duration and Frequency of activity	15 min 5 days per week
Indoor/Outdoor	Indoor
<b>Risk Management Measures</b>	
Local exhaust ventilation	Effectiveness: 90 %
Wear chemically resistant gloves in combination with 'basic' employee training.	Effectiveness: 90 %
Provide a good standard of general ventilation (not less than 3 - 5 air changes per hour)	Effectiveness: 30 %
Avoid frequent and direct contact with substance. Supervision in place to check that the RMMs in place are being used correctly and OCs followed. Clean equipment and the work area every day. Ensure minimization of manual phases	
Use suitable chemically resistant gloves., Wear suitable working clothes., Change gloves, if duration of activity exceeds break through time	
Use suitable eye protection.	
<b>Exposure estimate and reference to its source</b>	
Assessment method	EASY TRA v3.5, ECETOC TRA v3.0, Worker Worker - dermal, long-term - systemic
Exposure estimate	1.3714 mg/kg bw/day
Risk Characterization Ratio (RCR)	0.165232
Assessment method	EASY TRA v3.5, ECETOC TRA v3.0, Worker Worker - inhalation, long-term - local
Exposure estimate	0.5959 mg/m <sup>3</sup>
Risk Characterization Ratio (RCR)	0.595904
<b>Guidance to Downstream Users</b>	

BASF Safety data sheet according to Regulation UK SI 2019/758 and UK SI 2020/1577 as amended from time to time.

Date / Revised: 15.12.2022

Version: 11.0

Date previous version: 29.03.2022

Previous version: 10.0

Date / First version: 08.08.2002

Product: **Baxxodur® EC 280**

(ID no. 30340659/SDS\_GEN\_GB/EN)

Date of print 26.02.2024

For scaling see: <http://www.ecetoc.org/tra>

<b>Contributing exposure scenario</b>	
<b>Use descriptors covered</b>	PROC8b: Transfer of substance or mixture (charging and discharging) at dedicated facilities Use domain: professional
<b>Operational conditions</b>	
Concentration of the substance	3,3'-[Butane-1,4-diylbis(oxy)]bispropanamine Content: >= 0 % - <= 100 %
Physical state	liquid
Vapour pressure of the substance during use	0.067 Pa
Process temperature	20 °C
Duration and Frequency of activity	30 min 5 days per week
Indoor/Outdoor	Outdoor
<b>Risk Management Measures</b>	
Wear chemically resistant gloves in combination with 'basic' employee training.	Effectiveness: 90 %
Avoid frequent and direct contact with substance. Supervision in place to check that the RMMs in place are being used correctly and OCs followed. Clean equipment and the work area every day. Ensure minimization of manual phases	
Use suitable chemically resistant gloves., Wear suitable working clothes., Change gloves, if duration of activity exceeds break through time	
Use suitable eye protection.	
<b>Exposure estimate and reference to its source</b>	
Assessment method	EASY TRA v3.5, ECETOC TRA v3.0, worker, modified version, The duration of activity has been considered using a linear approach.
	Worker - dermal, long-term - systemic
Exposure estimate	0.0857 mg/kg bw/day
Risk Characterization Ratio (RCR)	0.010327
Assessment method	EASY TRA v3.5, ECETOC TRA v3.0, worker, modified version, The duration of activity has been considered using a linear approach.
	Worker - inhalation, long-term - local
Exposure estimate	0.3724 mg/m <sup>3</sup>
Risk Characterization Ratio (RCR)	0.37244
<b>Guidance to Downstream Users</b>	

BASF Safety data sheet according to Regulation UK SI 2019/758 and UK SI 2020/1577 as amended from time to time.

Date / Revised: 15.12.2022

Version: 11.0

Date previous version: 29.03.2022

Previous version: 10.0

Date / First version: 08.08.2002

Product: **Baxxodur® EC 280**

(ID no. 30340659/SDS\_GEN\_GB/EN)

Date of print 26.02.2024

For scaling see: <http://www.ecetoc.org/tra> Please note that a modified version has been used (see exposure estimates)

<b>Contributing exposure scenario</b>	
<b>Use descriptors covered</b>	PROC9: Transfer of substance or preparation into small containers (dedicated filling line, including weighing). Use domain: professional
<b>Operational conditions</b>	
Concentration of the substance	3,3'-[Butane-1,4-diylbis(oxy)]bispropanamine Content: >= 0 % - <= 100 %
Physical state	liquid
Vapour pressure of the substance during use	0.067 Pa
Process temperature	20 °C
Duration and Frequency of activity	30 min 5 days per week
Indoor/Outdoor	Outdoor
<b>Risk Management Measures</b>	
Wear chemically resistant gloves in combination with 'basic' employee training.	Effectiveness: 90 %
Avoid frequent and direct contact with substance. Supervision in place to check that the RMMs in place are being used correctly and OCs followed. Clean equipment and the work area every day. Ensure minimization of manual phases	
Use suitable chemically resistant gloves., Wear suitable working clothes., Change gloves, if duration of activity exceeds break through time	
Use suitable eye protection.	
<b>Exposure estimate and reference to its source</b>	
Assessment method	EASY TRA v3.5, ECETOC TRA v3.0, worker, modified version, The duration of activity has been considered using a linear approach.
	Worker - dermal, long-term - systemic
Exposure estimate	0.0429 mg/kg bw/day
Risk Characterization Ratio (RCR)	0.005164
Assessment method	EASY TRA v3.5, ECETOC TRA v3.0, worker, modified version, The duration of activity has been considered using a linear approach.
	Worker - inhalation, long-term - local
Exposure estimate	0.3724 mg/m <sup>3</sup>
Risk Characterization Ratio (RCR)	0.37244

BASF Safety data sheet according to Regulation UK SI 2019/758 and UK SI 2020/1577 as amended from time to time.

Date / Revised: 15.12.2022

Version: 11.0

Date previous version: 29.03.2022

Previous version: 10.0

Date / First version: 08.08.2002

Product: **Baxxodur® EC 280**

(ID no. 30340659/SDS\_GEN\_GB/EN)

Date of print 26.02.2024

### **Guidance to Downstream Users**

For scaling see: <http://www.ecetoc.org/tra> Please note that a modified version has been used (see exposure estimates)

### **Contributing exposure scenario**

<b>Use descriptors covered</b>	PROC9: Transfer of substance or preparation into small containers (dedicated filling line, including weighing). Use domain: professional
--------------------------------	---

### **Operational conditions**

Concentration of the substance	3,3'-[Butane-1,4-diylbis(oxy)]bispropanamine Content: >= 0 % - <= 100 %
--------------------------------	--

Physical state	liquid
----------------	--------

Vapour pressure of the substance during use	0.067 Pa
---	----------

Process temperature	20 °C
---------------------	-------

Duration and Frequency of activity	10 min 5 days per week
------------------------------------	------------------------

Indoor/Outdoor	Indoor
----------------	--------

### **Risk Management Measures**

Local exhaust ventilation	Effectiveness: 80 %
---------------------------	---------------------

Wear chemically resistant gloves in combination with 'basic' employee training.	Effectiveness: 90 %
---	---------------------

Avoid frequent and direct contact with substance. Supervision in place to check that the RMMs in place are being used correctly and OCs followed. Clean equipment and the work area every day. Ensure minimization of manual phases	
---	--

Use suitable chemically resistant gloves., Wear suitable working clothes., Change gloves, if duration of activity exceeds break through time	
--	--

Use suitable eye protection.	
------------------------------	--

### **Exposure estimate and reference to its source**

Assessment method	EASY TRA v3.5, ECETOC TRA v3.0, worker, modified version, The duration of activity has been considered using a linear approach.
-------------------	---

	Worker - dermal, long-term - systemic
--	---------------------------------------

Exposure estimate	0.0143 mg/kg bw/day
-------------------	---------------------

Risk Characterization Ratio (RCR)	0.001721
-----------------------------------	----------

Assessment method	EASY TRA v3.5, ECETOC TRA v3.0, worker, modified version, The duration of activity has been considered using a linear approach.
-------------------	---

	Worker - inhalation, long-term - local
--	--

BASF Safety data sheet according to Regulation UK SI 2019/758 and UK SI 2020/1577 as amended from time to time.

Date / Revised: 15.12.2022

Version: 11.0

Date previous version: 29.03.2022

Previous version: 10.0

Date / First version: 08.08.2002

Product: **Baxxodur® EC 280**

(ID no. 30340659/SDS\_GEN\_GB/EN)

Date of print 26.02.2024

Exposure estimate	0.3547 mg/m <sup>3</sup>
Risk Characterization Ratio (RCR)	0.354705
<b>Guidance to Downstream Users</b>	
For scaling see: <a href="http://www.ecetoc.org/tra">http://www.ecetoc.org/tra</a> Please note that a modified version has been used (see exposure estimates)	

\*\*\*\*\*

### 3. Short title of exposure scenario

Formulation

SU3; ERC2; PROC1, PROC2, PROC3, PROC4, PROC5

### Control of exposure and risk management measures

<b>Contributing exposure scenario</b>	
<b>Use descriptors covered</b>	ERC2: Formulation into mixture
<b>Operational conditions</b>	
Annual amount used in the EU	5,000 kg
Minimum emission days per year	10
Emission factor air	0.25 %
Emission factor water	0.5 %
Emission factor soil	0.01 %
Receive Surf. Water (Flow Rate).	18,000 m <sup>3</sup> /d
Dilution factor river	10
Dilution factor coast	100
<b>Risk Management Measures</b>	
Air treatment measures considered suitable are, e.g.	Exhaust air scrubber, Waste gas treatment by thermal oxidation
Wastewater treatment measures considered suitable are, e.g.	Aerobic biological treatment
Soil treatment measures considered suitable are, e.g.	No application of sludge to soil, Sealing of all relevant soil surfaces, Sewage Sludge incineration
	No application of sludge to soil
Type of STP	Municipal STP
Assumed sewage treatment plant flow (m <sup>3</sup> /d)	2,000 m <sup>3</sup> /d
<b>Exposure estimate and reference to its source</b>	
Assessment method	EASY TRA v4.2, ECETOC TRA v3.0, Environment
Risk Characterization Ratio (RCR)	0.569111

BASF Safety data sheet according to Regulation UK SI 2019/758 and UK SI 2020/1577 as amended from time to time.

Date / Revised: 15.12.2022

Version: 11.0

Date previous version: 29.03.2022

Previous version: 10.0

Date / First version: 08.08.2002

Product: **Baxxodur® EC 280**

(ID no. 30340659/SDS\_GEN\_GB/EN)

Date of print 26.02.2024

	Risk from environmental exposure is driven by marine water.
Maximum amount of safe use	878.6 kg/d
Risk from environmental exposure is driven by marine water.	

<b>Contributing exposure scenario</b>	
<b>Use descriptors covered</b>	PROC1: Chemical production or refinery in closed process without likelihood of exposure or processes with equivalent containment conditions. Use domain: industrial
<b>Operational conditions</b>	
Concentration of the substance	3,3'-[Butane-1,4-diylbis(oxy)]bispropanamine Content: >= 0 % - <= 100 %
Physical state	liquid
Vapour pressure of the substance during use	0.067 Pa
Process temperature	20 °C
Duration and Frequency of activity	480 min 5 days per week
Indoor/Outdoor	Indoor
<b>Risk Management Measures</b>	
Wear chemically resistant gloves in combination with specific activity training	Effectiveness: 95 %
Avoid frequent and direct contact with substance. Supervision in place to check that the RMMs in place are being used correctly and OCs followed. Clean equipment and the work area every day. Ensure minimization of manual phases	
Use suitable chemically resistant gloves., Wear suitable working clothes., Change gloves, if duration of activity exceeds break through time	
Use suitable eye protection.	
<b>Exposure estimate and reference to its source</b>	
Assessment method	EASY TRA v3.5, ECETOC TRA v3.0, Worker
	Worker - dermal, long-term - systemic
Exposure estimate	0.0017 mg/kg bw/day
Risk Characterization Ratio (RCR)	0.000207
Assessment method	EASY TRA v3.5, ECETOC TRA v3.0, Worker
	Worker - inhalation, long-term - local
Exposure estimate	0.0851 mg/m <sup>3</sup>

BASF Safety data sheet according to Regulation UK SI 2019/758 and UK SI 2020/1577 as amended from time to time.

Date / Revised: 15.12.2022

Version: 11.0

Date previous version: 29.03.2022

Previous version: 10.0

Date / First version: 08.08.2002

Product: **Baxxodur® EC 280**

(ID no. 30340659/SDS\_GEN\_GB/EN)

Date of print 26.02.2024

Risk Characterization Ratio (RCR)	0.085129
<b>Guidance to Downstream Users</b>	
For scaling see: <a href="http://www.ecetoc.org/tra">http://www.ecetoc.org/tra</a>	

<b>Contributing exposure scenario</b>	
<b>Use descriptors covered</b>	PROC2: Chemical production or refinery in closed continuous process with occasional controlled exposure or processes with equivalent containment conditions Use domain: industrial
<b>Operational conditions</b>	
Concentration of the substance	3,3'-[Butane-1,4-diylbis(oxy)]bispropanamine Content: >= 0 % - <= 100 %
Physical state	liquid
Vapour pressure of the substance during use	0.067 Pa
Process temperature	20 °C
Duration and Frequency of activity	480 min 5 days per week
Indoor/Outdoor	Indoor
<b>Risk Management Measures</b>	
Local exhaust ventilation	Effectiveness: 90 %
Wear chemically resistant gloves in combination with specific activity training	Effectiveness: 95 %
Avoid frequent and direct contact with substance. Supervision in place to check that the RMMs in place are being used correctly and OCs followed. Clean equipment and the work area every day. Ensure minimization of manual phases	
Use suitable chemically resistant gloves., Wear suitable working clothes., Change gloves, if duration of activity exceeds break through time	
Use suitable eye protection.	
<b>Exposure estimate and reference to its source</b>	
Assessment method	EASY TRA v3.5, ECETOC TRA v3.0, Worker Worker - dermal, long-term - systemic
Exposure estimate	0.0686 mg/kg bw/day
Risk Characterization Ratio (RCR)	0.008262
Assessment method	EASY TRA v3.5, ECETOC TRA v3.0, Worker Worker - inhalation, long-term - local
Exposure estimate	0.8513 mg/m <sup>3</sup>
Risk Characterization Ratio (RCR)	0.851291
<b>Guidance to Downstream Users</b>	

BASF Safety data sheet according to Regulation UK SI 2019/758 and UK SI 2020/1577 as amended from time to time.

Date / Revised: 15.12.2022

Version: 11.0

Date previous version: 29.03.2022

Previous version: 10.0

Date / First version: 08.08.2002

Product: **Baxxodur® EC 280**

(ID no. 30340659/SDS\_GEN\_GB/EN)

Date of print 26.02.2024

For scaling see: <http://www.ecetoc.org/tra>

<b>Contributing exposure scenario</b>	
<b>Use descriptors covered</b>	PROC3: Manufacture or formulation in the chemical industry in closed batch processes with occasional controlled exposure or processes with equivalent containment condition Use domain: industrial
<b>Operational conditions</b>	
Concentration of the substance	3,3'-[Butane-1,4-diylbis(oxy)]bispropanamine Content: >= 0 % - <= 25 %
Physical state	liquid
Vapour pressure of the substance during use	0.067 Pa
	Air concentration is limited to the saturated air concentration of the pure compound.
Duration and Frequency of activity	480 min 5 days per week
Indoor/Outdoor	Indoor
	Assumes activities are at ambient temperature.
<b>Risk Management Measures</b>	
Local exhaust ventilation	Effectiveness: 90 %
Wear chemically resistant gloves in combination with specific activity training	Effectiveness: 95 %
Provide a good standard of general ventilation (not less than 3 - 5 air changes per hour)	Effectiveness: 30 %
Avoid frequent and direct contact with substance. Supervision in place to check that the RMMs in place are being used correctly and OCs followed. Clean equipment and the work area every day. Ensure minimization of manual phases	
Use suitable chemically resistant gloves., Wear suitable working clothes., Change gloves, if duration of activity exceeds break through time	
Use suitable eye protection.	
<b>Exposure estimate and reference to its source</b>	
Assessment method	EASY TRA v4.2, ECETOC TRA v3.0, Worker Worker - dermal, long-term - systemic
Exposure estimate	0.0206 mg/kg bw/day
Risk Characterization Ratio (RCR)	0.002478
Assessment method	EASY TRA v4.2, ECETOC TRA v3.0, Worker Worker - inhalation, long-term - local

BASF Safety data sheet according to Regulation UK SI 2019/758 and UK SI 2020/1577 as amended from time to time.

Date / Revised: 15.12.2022

Version: 11.0

Date previous version: 29.03.2022

Previous version: 10.0

Date / First version: 08.08.2002

Product: **Baxxodur® EC 280**

(ID no. 30340659/SDS\_GEN\_GB/EN)

Date of print 26.02.2024

Exposure estimate	0.5525 mg/m <sup>3</sup>
Risk Characterization Ratio (RCR)	0.552519
<b>Guidance to Downstream Users</b>	
For scaling see: <a href="http://www.ecetoc.org/tra">http://www.ecetoc.org/tra</a>	

<b>Contributing exposure scenario</b>	
<b>Use descriptors covered</b>	PROC4: Chemical production where opportunity for exposure arises Use domain: industrial
<b>Operational conditions</b>	
Concentration of the substance	3,3'-[Butane-1,4-diylbis(oxy)]bispropanamine Content: >= 0 % - <= 25 %
Physical state	liquid
Vapour pressure of the substance during use	0.067 Pa
	Air concentration is limited to the saturated air concentration of the pure compound.
Duration and Frequency of activity	480 min 5 days per week
Indoor/Outdoor	Indoor
	Assumes activities are at ambient temperature.
<b>Risk Management Measures</b>	
Local exhaust ventilation	Effectiveness: 90 %
Wear chemically resistant gloves in combination with specific activity training	Effectiveness: 95 %
Provide a good standard of general ventilation (not less than 3 - 5 air changes per hour)	Effectiveness: 30 %
Avoid frequent and direct contact with substance. Supervision in place to check that the RMMs in place are being used correctly and OCs followed. Clean equipment and the work area every day. Ensure minimization of manual phases	
Use suitable chemically resistant gloves., Wear suitable working clothes., Change gloves, if duration of activity exceeds break through time	
Use suitable eye protection.	
<b>Exposure estimate and reference to its source</b>	
Assessment method	EASY TRA v4.2, ECETOC TRA v3.0, Worker
	Worker - dermal, long-term - systemic
Exposure estimate	0.2057 mg/kg bw/day
Risk Characterization Ratio (RCR)	0.024785
Assessment method	EASY TRA v4.2, ECETOC TRA v3.0, Worker

BASF Safety data sheet according to Regulation UK SI 2019/758 and UK SI 2020/1577 as amended from time to time.

Date / Revised: 15.12.2022

Version: 11.0

Date previous version: 29.03.2022

Previous version: 10.0

Date / First version: 08.08.2002

Product: **Baxxodur® EC 280**

(ID no. 30340659/SDS\_GEN\_GB/EN)

Date of print 26.02.2024

	Worker - inhalation, long-term - local
Exposure estimate	0.5525 mg/m <sup>3</sup>
Risk Characterization Ratio (RCR)	0.552519
<b>Guidance to Downstream Users</b>	
For scaling see: <a href="http://www.ecetoc.org/tra">http://www.ecetoc.org/tra</a>	

<b>Contributing exposure scenario</b>	
<b>Use descriptors covered</b>	PROC5: Mixing or blending in batch processes Use domain: industrial
<b>Operational conditions</b>	
Concentration of the substance	3,3'-[Butane-1,4-diylbis(oxy)]bispropanamine Content: >= 0 % - <= 5 %
Physical state	liquid
Vapour pressure of the substance during use	0.067 Pa
Process temperature	20 °C
Duration and Frequency of activity	240 min 5 days per week
Indoor/Outdoor	Indoor
<b>Risk Management Measures</b>	
Local exhaust ventilation	Effectiveness: 90 %
Wear chemically resistant gloves in combination with specific activity training	Effectiveness: 95 %
Avoid frequent and direct contact with substance. Supervision in place to check that the RMMs in place are being used correctly and OCs followed. Clean equipment and the work area every day. Ensure minimization of manual phases	
Use suitable chemically resistant gloves., Wear suitable working clothes., Change gloves, if duration of activity exceeds break through time	
Use suitable eye protection.	
<b>Exposure estimate and reference to its source</b>	
Assessment method	EASY TRA v3.5, ECETOC TRA v3.0, Worker
	Worker - dermal, long-term - systemic
Exposure estimate	0.1371 mg/kg bw/day
Risk Characterization Ratio (RCR)	0.016523
Assessment method	EASY TRA v3.5, ECETOC TRA v3.0, Worker
	Worker - inhalation, long-term - local
Exposure estimate	0.5108 mg/m <sup>3</sup>
Risk Characterization Ratio (RCR)	0.510774
<b>Guidance to Downstream Users</b>	

BASF Safety data sheet according to Regulation UK SI 2019/758 and UK SI 2020/1577 as amended from time to time.

Date / Revised: 15.12.2022

Version: 11.0

Date previous version: 29.03.2022

Previous version: 10.0

Date / First version: 08.08.2002

Product: **Baxxodur® EC 280**

(ID no. 30340659/SDS\_GEN\_GB/EN)

Date of print 26.02.2024

For scaling see: <http://www.ecetoc.org/tra>

<b>Contributing exposure scenario</b>	
<b>Use descriptors covered</b>	PROC5: Mixing or blending in batch processes Use domain: industrial
<b>Operational conditions</b>	
Concentration of the substance	3,3'-[Butane-1,4-diylbis(oxy)]bispropanamine Content: >= 0 % - <= 25 %
Physical state	liquid
Vapour pressure of the substance during use	0.067 Pa
	Air concentration is limited to the saturated air concentration of the pure compound.
Duration and Frequency of activity	480 min 5 days per week
Indoor/Outdoor	Indoor
	Assumes activities are at ambient temperature.
<b>Risk Management Measures</b>	
Local exhaust ventilation	Effectiveness: 90 %
Wear chemically resistant gloves in combination with specific activity training	Effectiveness: 95 %
Provide a good standard of general ventilation (not less than 3 - 5 air changes per hour)	Effectiveness: 30 %
Avoid frequent and direct contact with substance. Supervision in place to check that the RMMs in place are being used correctly and OCs followed. Clean equipment and the work area every day. Ensure minimization of manual phases	
Use suitable chemically resistant gloves., Wear suitable working clothes., Change gloves, if duration of activity exceeds break through time	
Use suitable eye protection.	
<b>Exposure estimate and reference to its source</b>	
Assessment method	EASY TRA v4.2, ECETOC TRA v3.0, Worker
	Worker - dermal, long-term - systemic
Exposure estimate	0.4114 mg/kg bw/day
Risk Characterization Ratio (RCR)	0.04957
Assessment method	EASY TRA v4.2, ECETOC TRA v3.0, Worker
	Worker - inhalation, long-term - local
Exposure estimate	0.5525 mg/m <sup>3</sup>
Risk Characterization Ratio (RCR)	0.552519
<b>Guidance to Downstream Users</b>	

BASF Safety data sheet according to Regulation UK SI 2019/758 and UK SI 2020/1577 as amended from time to time.

Date / Revised: 15.12.2022

Version: 11.0

Date previous version: 29.03.2022

Previous version: 10.0

Date / First version: 08.08.2002

Product: **Baxxodur® EC 280**

(ID no. 30340659/SDS\_GEN\_GB/EN)

Date of print 26.02.2024

For scaling see: <http://www.ecetoc.org/tra>

\*\*\*\*\*

#### 4. Short title of exposure scenario

Formulation

SU22; ERC8a, ERC8c, ERC8f; PROC1, PROC2, PROC3, PROC4, PROC5

#### Control of exposure and risk management measures

Contributing exposure scenario	
<b>Use descriptors covered</b>	ERC8a: Widespread use of non-reactive processing aid (no inclusion into or onto article, indoor) As no environmental hazard was identified no environmental-related exposure assessment and risk characterization was performed.
<b>Operational conditions</b>	
Contributing exposure scenario	
<b>Use descriptors covered</b>	ERC8c: Widespread use leading to inclusion into/onto article (indoor) As no environmental hazard was identified no environmental-related exposure assessment and risk characterization was performed.
<b>Operational conditions</b>	
Contributing exposure scenario	
<b>Use descriptors covered</b>	ERC8f: Widespread use leading to inclusion into/onto article (outdoor) As no environmental hazard was identified no environmental-related exposure assessment and risk characterization was performed.
<b>Operational conditions</b>	
Contributing exposure scenario	
<b>Use descriptors covered</b>	PROC1: Chemical production or refinery in closed process without likelihood of exposure or processes with equivalent containment conditions. Use domain: professional
<b>Operational conditions</b>	
Concentration of the substance	3,3'-[Butane-1,4-diylbis(oxy)]bispropanamine Content: >= 0 % - <= 100 %
Physical state	liquid
Vapour pressure of the substance	0.067 Pa

BASF Safety data sheet according to Regulation UK SI 2019/758 and UK SI 2020/1577 as amended from time to time.

Date / Revised: 15.12.2022

Version: 11.0

Date previous version: 29.03.2022

Previous version: 10.0

Date / First version: 08.08.2002

Product: **Baxxodur® EC 280**

(ID no. 30340659/SDS\_GEN\_GB/EN)

Date of print 26.02.2024

during use	
Process temperature	20 °C
Duration and Frequency of activity	480 min 5 days per week
Indoor/Outdoor	Indoor
<b>Risk Management Measures</b>	
Wear chemically resistant gloves in combination with 'basic' employee training.	Effectiveness: 90 %
Avoid frequent and direct contact with substance. Supervision in place to check that the RMMs in place are being used correctly and OCs followed. Clean equipment and the work area every day. Ensure minimization of manual phases	
Use suitable chemically resistant gloves., Wear suitable working clothes., Change gloves, if duration of activity exceeds break through time	
Use suitable eye protection.	
<b>Exposure estimate and reference to its source</b>	
Assessment method	EASY TRA v3.5, ECETOC TRA v3.0, Worker
	Worker - dermal, long-term - systemic
Exposure estimate	0.0034 mg/kg bw/day
Risk Characterization Ratio (RCR)	0.000413
Assessment method	EASY TRA v3.5, ECETOC TRA v3.0, Worker
	Worker - inhalation, long-term - local
Exposure estimate	0.0851 mg/m <sup>3</sup>
Risk Characterization Ratio (RCR)	0.085129
<b>Guidance to Downstream Users</b>	
For scaling see: <a href="http://www.ecetoc.org/tra">http://www.ecetoc.org/tra</a>	

<b>Contributing exposure scenario</b>	
<b>Use descriptors covered</b>	PROC2: Chemical production or refinery in closed continuous process with occasional controlled exposure or processes with equivalent containment conditions Use domain: professional
<b>Operational conditions</b>	
Concentration of the substance	3,3'-[Butane-1,4-diylbis(oxy)]bispropanamine Content: >= 0 % - <= 100 %
Physical state	liquid
Vapour pressure of the substance during use	0.067 Pa
Process temperature	20 °C

BASF Safety data sheet according to Regulation UK SI 2019/758 and UK SI 2020/1577 as amended from time to time.

Date / Revised: 15.12.2022

Version: 11.0

Date previous version: 29.03.2022

Previous version: 10.0

Date / First version: 08.08.2002

Product: **Baxxodur® EC 280**

(ID no. 30340659/SDS\_GEN\_GB/EN)

Date of print 26.02.2024

Duration and Frequency of activity	30 min 5 days per week
Indoor/Outdoor	Indoor
<b>Risk Management Measures</b>	
Local exhaust ventilation	Effectiveness: 80 %
Wear chemically resistant gloves in combination with 'basic' employee training.	Effectiveness: 90 %
Provide a good standard of general ventilation (not less than 3 - 5 air changes per hour)	Effectiveness: 30 %
Avoid frequent and direct contact with substance. Supervision in place to check that the RMMs in place are being used correctly and OCs followed. Clean equipment and the work area every day. Ensure minimization of manual phases	
Use suitable chemically resistant gloves., Wear suitable working clothes., Change gloves, if duration of activity exceeds break through time	
Use suitable eye protection.	
<b>Exposure estimate and reference to its source</b>	
Assessment method	EASY TRA v3.5, ECETOC TRA v3.0, worker, modified version, The duration of activity has been considered using a linear approach.
	Worker - dermal, long-term - systemic
Exposure estimate	0.0086 mg/kg bw/day
Risk Characterization Ratio (RCR)	0.001033
Assessment method	EASY TRA v3.5, ECETOC TRA v3.0, worker, modified version, The duration of activity has been considered using a linear approach.
	Worker - inhalation, long-term - local
Exposure estimate	0.3724 mg/m <sup>3</sup>
Risk Characterization Ratio (RCR)	0.37244
<b>Guidance to Downstream Users</b>	
For scaling see: <a href="http://www.ecetoc.org/tra">http://www.ecetoc.org/tra</a> Please note that a modified version has been used (see exposure estimates)	
<b>Contributing exposure scenario</b>	
<b>Use descriptors covered</b>	PROC3: Manufacture or formulation in the chemical industry in closed batch processes with occasional controlled exposure or processes with equivalent containment condition Use domain: professional
<b>Operational conditions</b>	
Concentration of the substance	3,3'-[Butane-1,4-diylbis(oxy)]bispropanamine

BASF Safety data sheet according to Regulation UK SI 2019/758 and UK SI 2020/1577 as amended from time to time.

Date / Revised: 15.12.2022

Version: 11.0

Date previous version: 29.03.2022

Previous version: 10.0

Date / First version: 08.08.2002

Product: **Baxxodur® EC 280**

(ID no. 30340659/SDS\_GEN\_GB/EN)

Date of print 26.02.2024

	Content: $\geq 0\%$ - $\leq 100\%$
Physical state	liquid
Vapour pressure of the substance during use	0.067 Pa
Process temperature	20 °C
Duration and Frequency of activity	120 min 5 days per week
Indoor/Outdoor	Indoor
<b>Risk Management Measures</b>	
Local exhaust ventilation	Effectiveness: 80 %
Wear chemically resistant gloves in combination with 'basic' employee training.	Effectiveness: 90 %
Provide a good standard of general ventilation (not less than 3 - 5 air changes per hour)	Effectiveness: 30 %
Avoid frequent and direct contact with substance. Supervision in place to check that the RMMs in place are being used correctly and OCs followed. Clean equipment and the work area every day. Ensure minimization of manual phases	
Use suitable chemically resistant gloves., Wear suitable working clothes., Change gloves, if duration of activity exceeds break through time	
Use suitable eye protection.	
<b>Exposure estimate and reference to its source</b>	
Assessment method	EASY TRA v3.5, ECETOC TRA v3.0, worker, modified version, The duration of activity has been considered using a linear approach.
	Worker - dermal, long-term - systemic
Exposure estimate	0.0171 mg/kg bw/day
Risk Characterization Ratio (RCR)	0.002065
Assessment method	EASY TRA v3.5, ECETOC TRA v3.0, worker, modified version, The duration of activity has been considered using a linear approach.
	Worker - inhalation, long-term - local
Exposure estimate	0.8939 mg/m <sup>3</sup>
Risk Characterization Ratio (RCR)	0.893855
<b>Guidance to Downstream Users</b>	
For scaling see: <a href="http://www.ecetoc.org/tra">http://www.ecetoc.org/tra</a> Please note that a modified version has been used (see exposure estimates)	

**Contributing exposure scenario**

<b>Use descriptors covered</b>	PROC4: Chemical production where opportunity for
--------------------------------	--

BASF Safety data sheet according to Regulation UK SI 2019/758 and UK SI 2020/1577 as amended from time to time.

Date / Revised: 15.12.2022

Version: 11.0

Date previous version: 29.03.2022

Previous version: 10.0

Date / First version: 08.08.2002

Product: **Baxxodur® EC 280**

(ID no. 30340659/SDS\_GEN\_GB/EN)

Date of print 26.02.2024

	exposure arises Use domain: professional
<b>Operational conditions</b>	
Concentration of the substance	3,3'-[Butane-1,4-diylbis(oxy)]bispropanamine Content: >= 0 % - <= 100 %
Physical state	liquid
Vapour pressure of the substance during use	0.067 Pa
Process temperature	20 °C
Duration and Frequency of activity	30 min 5 days per week
Indoor/Outdoor	Indoor
<b>Risk Management Measures</b>	
Local exhaust ventilation	Effectiveness: 80 %
Wear chemically resistant gloves in combination with 'basic' employee training.	Effectiveness: 90 %
Provide a good standard of general ventilation (not less than 3 - 5 air changes per hour)	Effectiveness: 30 %
Avoid frequent and direct contact with substance. Supervision in place to check that the RMMs in place are being used correctly and OCs followed. Clean equipment and the work area every day. Ensure minimization of manual phases	
Use suitable chemically resistant gloves., Wear suitable working clothes., Change gloves, if duration of activity exceeds break through time	
Use suitable eye protection.	
<b>Exposure estimate and reference to its source</b>	
Assessment method	EASY TRA v3.5, ECETOC TRA v3.0, worker, modified version, The duration of activity has been considered using a linear approach.
	Worker - dermal, long-term - systemic
Exposure estimate	0.0429 mg/kg bw/day
Risk Characterization Ratio (RCR)	0.005164
Assessment method	EASY TRA v3.5, ECETOC TRA v3.0, worker, modified version, The duration of activity has been considered using a linear approach.
	Worker - inhalation, long-term - local
Exposure estimate	0.7449 mg/m <sup>3</sup>
Risk Characterization Ratio (RCR)	0.744879
<b>Guidance to Downstream Users</b>	

BASF Safety data sheet according to Regulation UK SI 2019/758 and UK SI 2020/1577 as amended from time to time.

Date / Revised: 15.12.2022

Version: 11.0

Date previous version: 29.03.2022

Previous version: 10.0

Date / First version: 08.08.2002

Product: **Baxxodur® EC 280**

(ID no. 30340659/SDS\_GEN\_GB/EN)

Date of print 26.02.2024

For scaling see: <http://www.ecetoc.org/tra> Please note that a modified version has been used (see exposure estimates)

<b>Contributing exposure scenario</b>	
<b>Use descriptors covered</b>	PROC5: Mixing or blending in batch processes Use domain: professional
<b>Operational conditions</b>	
Concentration of the substance	3,3'-[Butane-1,4-diylbis(oxy)]bispropanamine Content: >= 0 % - <= 5 %
Physical state	liquid
Vapour pressure of the substance during use	0.067 Pa
Process temperature	20 °C
Duration and Frequency of activity	60 min 5 days per week
Indoor/Outdoor	Indoor
<b>Risk Management Measures</b>	
Local exhaust ventilation	Effectiveness: 80 %
Wear chemically resistant gloves in combination with 'basic' employee training.	Effectiveness: 90 %
Provide a good standard of general ventilation (not less than 3 - 5 air changes per hour)	Effectiveness: 30 %
Avoid frequent and direct contact with substance. Supervision in place to check that the RMMs in place are being used correctly and OCs followed. Clean equipment and the work area every day. Ensure minimization of manual phases	
Use suitable chemically resistant gloves., Wear suitable working clothes., Change gloves, if duration of activity exceeds break through time	
Use suitable eye protection.	
<b>Exposure estimate and reference to its source</b>	
Assessment method	EASY TRA v3.5, ECETOC TRA v3.0, Worker Worker - dermal, long-term - systemic
Exposure estimate	0.2743 mg/kg bw/day
Risk Characterization Ratio (RCR)	0.033046
Assessment method	EASY TRA v3.5, ECETOC TRA v3.0, Worker Worker - inhalation, long-term - local
Exposure estimate	0.4767 mg/m <sup>3</sup>
Risk Characterization Ratio (RCR)	0.476723
<b>Guidance to Downstream Users</b>	

BASF Safety data sheet according to Regulation UK SI 2019/758 and UK SI 2020/1577 as amended from time to time.

Date / Revised: 15.12.2022

Version: 11.0

Date previous version: 29.03.2022

Previous version: 10.0

Date / First version: 08.08.2002

Product: **Baxxodur® EC 280**

(ID no. 30340659/SDS\_GEN\_GB/EN)

Date of print 26.02.2024

For scaling see: <http://www.ecetoc.org/tra>

<b>Contributing exposure scenario</b>	
<b>Use descriptors covered</b>	PROC5: Mixing or blending in batch processes Use domain: professional
<b>Operational conditions</b>	
Concentration of the substance	3,3'-[Butane-1,4-diylbis(oxy)]bispropanamine Content: >= 0 % - <= 100 %
Physical state	liquid
Vapour pressure of the substance during use	0.067 Pa
Process temperature	20 °C
Duration and Frequency of activity	10 min 5 days per week
Indoor/Outdoor	Indoor
<b>Risk Management Measures</b>	
Local exhaust ventilation	Effectiveness: 80 %
Wear chemically resistant gloves in combination with 'basic' employee training.	Effectiveness: 90 %
Provide a good standard of general ventilation (not less than 3 - 5 air changes per hour)	Effectiveness: 30 %
Avoid frequent and direct contact with substance. Supervision in place to check that the RMMs in place are being used correctly and OCs followed. Clean equipment and the work area every day. Ensure minimization of manual phases	
Use suitable chemically resistant gloves., Wear suitable working clothes., Change gloves, if duration of activity exceeds break through time	
Use suitable eye protection.	
<b>Exposure estimate and reference to its source</b>	
Assessment method	EASY TRA v3.5, ECETOC TRA v3.0, worker, modified version, The duration of activity has been considered using a linear approach.
	Worker - dermal, long-term - systemic
Exposure estimate	0.0286 mg/kg bw/day
Risk Characterization Ratio (RCR)	0.003442
Assessment method	EASY TRA v3.5, ECETOC TRA v3.0, worker, modified version, The duration of activity has been considered using a linear approach.
	Worker - inhalation, long-term - local

BASF Safety data sheet according to Regulation UK SI 2019/758 and UK SI 2020/1577 as amended from time to time.

Date / Revised: 15.12.2022

Version: 11.0

Date previous version: 29.03.2022

Previous version: 10.0

Date / First version: 08.08.2002

Product: **Baxxodur® EC 280**

(ID no. 30340659/SDS\_GEN\_GB/EN)

Date of print 26.02.2024

Exposure estimate	0.2483 mg/m <sup>3</sup>
Risk Characterization Ratio (RCR)	0.248293
<b>Guidance to Downstream Users</b>	
For scaling see: <a href="http://www.ecetoc.org/tra">http://www.ecetoc.org/tra</a> Please note that a modified version has been used (see exposure estimates)	

\*\*\*\*\*

## 5. Short title of exposure scenario

Use in laboratories

SU3; ERC4; PROC15

## Control of exposure and risk management measures

<b>Contributing exposure scenario</b>	
<b>Use descriptors covered</b>	ERC4: Use of non-reactive processing aid at industrial site (no inclusion into or onto article)
<b>Operational conditions</b>	
Annual amount used in the EU	100 kg
Minimum emission days per year	20
Emission factor air	2.5 %
Emission factor water	2 %
Emission factor soil	0 %
Receive Surf. Water (Flow Rate).	18,000 m <sup>3</sup> /d
Dilution factor river	10
Dilution factor coast	100
<b>Risk Management Measures</b>	
Air treatment measures considered suitable are, e.g.	Waste gas treatment by thermal oxidation, Exhaust air scrubber
Wastewater treatment measures considered suitable are, e.g.	Aerobic biological treatment
Soil treatment measures considered suitable are, e.g.	Sewage Sludge incineration, No application of sludge to soil, Sealing of all relevant soil surfaces
	No application of sludge to soil
Type of STP	Municipal STP
Assumed sewage treatment plant flow (m <sup>3</sup> /d)	2,000 m <sup>3</sup> /d
<b>Exposure estimate and reference to its source</b>	
Assessment method	EASY TRA v4.2, ECETOC TRA v3.0, Environment

BASF Safety data sheet according to Regulation UK SI 2019/758 and UK SI 2020/1577 as amended from time to time.

Date / Revised: 15.12.2022

Version: 11.0

Date previous version: 29.03.2022

Previous version: 10.0

Date / First version: 08.08.2002

Product: **Baxxodur® EC 280**

(ID no. 30340659/SDS\_GEN\_GB/EN)

Date of print 26.02.2024

Risk Characterization Ratio (RCR)	0.023696
	Risk from environmental exposure is driven by marine water.
Maximum amount of safe use	211 kg/d
Risk from environmental exposure is driven by marine water.	

<b>Contributing exposure scenario</b>	
<b>Use descriptors covered</b>	PROC15: Use a laboratory reagent. Use domain: industrial
<b>Operational conditions</b>	
Concentration of the substance	3,3'-[Butane-1,4-diylbis(oxy)]bispropanamine Content: >= 0 % - <= 100 %
Physical state	liquid
Vapour pressure of the substance during use	0.067 Pa
	Air concentration is limited to the saturated air concentration of the pure compound.
Duration and Frequency of activity	480 min 5 days per week
Indoor/Outdoor	Indoor
	Assumes activities are at ambient temperature.
<b>Risk Management Measures</b>	
Local exhaust ventilation	Effectiveness: 90 %
Wear chemically resistant gloves in combination with specific activity training	Effectiveness: 95 %
Provide a good standard of general ventilation (not less than 3 - 5 air changes per hour)	Effectiveness: 30 %
Avoid frequent and direct contact with substance. Supervision in place to check that the RMMs in place are being used correctly and OCs followed. Clean equipment and the work area every day. Ensure minimization of manual phases	
Use suitable chemically resistant gloves., Wear suitable working clothes., Change gloves, if duration of activity exceeds break through time	
Use suitable eye protection.	
<b>Exposure estimate and reference to its source</b>	
Assessment method	EASY TRA v4.2, ECETOC TRA v3.0, Worker
	Worker - dermal, long-term - systemic
Exposure estimate	0.0171 mg/kg bw/day

BASF Safety data sheet according to Regulation UK SI 2019/758 and UK SI 2020/1577 as amended from time to time.

Date / Revised: 15.12.2022

Version: 11.0

Date previous version: 29.03.2022

Previous version: 10.0

Date / First version: 08.08.2002

Product: **Baxxodur® EC 280**

(ID no. 30340659/SDS\_GEN\_GB/EN)

Date of print 26.02.2024

Risk Characterization Ratio (RCR)	0.002065
Assessment method	EASY TRA v4.2, ECETOC TRA v3.0, Worker
	Worker - inhalation, long-term - local
Exposure estimate	0.5525 mg/m <sup>3</sup>
Risk Characterization Ratio (RCR)	0.552519
<b>Guidance to Downstream Users</b>	
For scaling see: <a href="http://www.ecetoc.org/tra">http://www.ecetoc.org/tra</a>	

\*\*\*\*\*

## 6. Short title of exposure scenario

Use in laboratories

SU22; ERC8a; PROC15

## Control of exposure and risk management measures

<b>Contributing exposure scenario</b>	
<b>Use descriptors covered</b>	ERC8a: Widespread use of non-reactive processing aid (no inclusion into or onto article, indoor) As no environmental hazard was identified no environmental-related exposure assessment and risk characterization was performed.
<b>Operational conditions</b>	

<b>Contributing exposure scenario</b>	
<b>Use descriptors covered</b>	PROC15: Use a laboratory reagent. Use domain: professional
<b>Operational conditions</b>	
Concentration of the substance	3,3'-[Butane-1,4-diylbis(oxy)]bispropanamine Content: >= 0 % - <= 100 %
Physical state	liquid
Vapour pressure of the substance during use	0.067 Pa
Process temperature	20 °C
Duration and Frequency of activity	30 min 5 days per week
Indoor/Outdoor	Indoor
<b>Risk Management Measures</b>	
Local exhaust ventilation	Effectiveness: 80 %
Wear chemically resistant gloves in combination with 'basic' employee training.	Effectiveness: 90 %
Avoid frequent and direct contact with substance. Supervision in place to check that the RMMs in place are	

BASF Safety data sheet according to Regulation UK SI 2019/758 and UK SI 2020/1577 as amended from time to time.

Date / Revised: 15.12.2022

Version: 11.0

Date previous version: 29.03.2022

Previous version: 10.0

Date / First version: 08.08.2002

Product: **Baxxodur® EC 280**

(ID no. 30340659/SDS\_GEN\_GB/EN)

Date of print 26.02.2024

being used correctly and OCs followed. Clean equipment and the work area every day. Ensure minimization of manual phases	
Use suitable chemically resistant gloves., Wear suitable working clothes., Change gloves, if duration of activity exceeds break through time	
Use suitable eye protection.	
<b>Exposure estimate and reference to its source</b>	
Assessment method	EASY TRA v3.5, ECETOC TRA v3.0, worker, modified version, The duration of activity has been considered using a linear approach.
	Worker - dermal, long-term - systemic
Exposure estimate	0.0021 mg/kg bw/day
Risk Characterization Ratio (RCR)	0.000258
Assessment method	EASY TRA v3.5, ECETOC TRA v3.0, worker, modified version, The duration of activity has been considered using a linear approach.
	Worker - inhalation, long-term - local
Exposure estimate	0.5321 mg/m <sup>3</sup>
Risk Characterization Ratio (RCR)	0.532057
<b>Guidance to Downstream Users</b>	
For scaling see: <a href="http://www.ecetoc.org/tra">http://www.ecetoc.org/tra</a> Please note that a modified version has been used (see exposure estimates)	

\*\*\*\*\*

## 7. Short title of exposure scenario

Use as a Process chemical

SU3; ERC4; PROC1, PROC2, PROC3, PROC4

## Control of exposure and risk management measures

<b>Contributing exposure scenario</b>	
<b>Use descriptors covered</b>	ERC4: Use of non-reactive processing aid at industrial site (no inclusion into or onto article) As no environmental hazard was identified no environmental-related exposure assessment and risk characterization was performed.
<b>Operational conditions</b>	
<b>Contributing exposure scenario</b>	
<b>Use descriptors covered</b>	PROC1: Chemical production or refinery in closed process without likelihood of exposure or processes with equivalent containment conditions. Use domain: industrial

BASF Safety data sheet according to Regulation UK SI 2019/758 and UK SI 2020/1577 as amended from time to time.

Date / Revised: 15.12.2022

Version: 11.0

Date previous version: 29.03.2022

Previous version: 10.0

Date / First version: 08.08.2002

Product: **Baxxodur® EC 280**

(ID no. 30340659/SDS\_GEN\_GB/EN)

Date of print 26.02.2024

<b>Operational conditions</b>	
Concentration of the substance	3,3'-[Butane-1,4-diylbis(oxy)]bispropanamine Content: >= 0 % - <= 100 %
Physical state	liquid
Vapour pressure of the substance during use	0.067 Pa
Process temperature	20 °C
Duration and Frequency of activity	480 min 5 days per week
Indoor/Outdoor	Indoor
<b>Risk Management Measures</b>	
Wear chemically resistant gloves in combination with specific activity training	Effectiveness: 95 %
Avoid frequent and direct contact with substance. Supervision in place to check that the RMMs in place are being used correctly and OCs followed. Clean equipment and the work area every day. Ensure minimization of manual phases	
Use suitable chemically resistant gloves., Wear suitable working clothes., Change gloves, if duration of activity exceeds break through time	
Use suitable eye protection.	
<b>Exposure estimate and reference to its source</b>	
Assessment method	EASY TRA v3.5, ECETOC TRA v3.0, Worker Worker - dermal, long-term - systemic
Exposure estimate	0.0017 mg/kg bw/day
Risk Characterization Ratio (RCR)	0.000207
Assessment method	EASY TRA v3.5, ECETOC TRA v3.0, Worker Worker - inhalation, long-term - local
Exposure estimate	0.0851 mg/m <sup>3</sup>
Risk Characterization Ratio (RCR)	0.085129
<b>Guidance to Downstream Users</b>	
For scaling see: <a href="http://www.ecetoc.org/tra">http://www.ecetoc.org/tra</a>	
<b>Contributing exposure scenario</b>	
<b>Use descriptors covered</b>	PROC2: Chemical production or refinery in closed continuous process with occasional controlled exposure or processes with equivalent containment conditions Use domain: industrial
<b>Operational conditions</b>	
Concentration of the substance	3,3'-[Butane-1,4-diylbis(oxy)]bispropanamine Content: >= 0 % - <= 100 %

BASF Safety data sheet according to Regulation UK SI 2019/758 and UK SI 2020/1577 as amended from time to time.

Date / Revised: 15.12.2022

Version: 11.0

Date previous version: 29.03.2022

Previous version: 10.0

Date / First version: 08.08.2002

Product: **Baxxodur® EC 280**

(ID no. 30340659/SDS\_GEN\_GB/EN)

Date of print 26.02.2024

Physical state	liquid
Vapour pressure of the substance during use	0.067 Pa
Process temperature	20 °C
Duration and Frequency of activity	480 min 5 days per week
Indoor/Outdoor	Indoor
<b>Risk Management Measures</b>	
Local exhaust ventilation	Effectiveness: 90 %
Wear chemically resistant gloves in combination with specific activity training	Effectiveness: 95 %
Avoid frequent and direct contact with substance. Supervision in place to check that the RMMs in place are being used correctly and OCs followed. Clean equipment and the work area every day. Ensure minimization of manual phases	
Use suitable chemically resistant gloves., Wear suitable working clothes., Change gloves, if duration of activity exceeds break through time	
Use suitable eye protection.	
<b>Exposure estimate and reference to its source</b>	
Assessment method	EASY TRA v3.5, ECETOC TRA v3.0, Worker
	Worker - dermal, long-term - systemic
Exposure estimate	0.0686 mg/kg bw/day
Risk Characterization Ratio (RCR)	0.008262
Assessment method	EASY TRA v3.5, ECETOC TRA v3.0, Worker
	Worker - inhalation, long-term - local
Exposure estimate	0.8513 mg/m <sup>3</sup>
Risk Characterization Ratio (RCR)	0.851291
<b>Guidance to Downstream Users</b>	
For scaling see: <a href="http://www.ecetoc.org/tra">http://www.ecetoc.org/tra</a>	

<b>Contributing exposure scenario</b>	
<b>Use descriptors covered</b>	PROC3: Manufacture or formulation in the chemical industry in closed batch processes with occasional controlled exposure or processes with equivalent containment condition Use domain: industrial
<b>Operational conditions</b>	
Concentration of the substance	3,3'-[Butane-1,4-diylbis(oxy)]bispropanamine Content: >= 0 % - <= 100 %

BASF Safety data sheet according to Regulation UK SI 2019/758 and UK SI 2020/1577 as amended from time to time.

Date / Revised: 15.12.2022

Version: 11.0

Date previous version: 29.03.2022

Previous version: 10.0

Date / First version: 08.08.2002

Product: **Baxxodur® EC 280**

(ID no. 30340659/SDS\_GEN\_GB/EN)

Date of print 26.02.2024

Physical state	liquid
Vapour pressure of the substance during use	0.067 Pa
Process temperature	20 °C
Duration and Frequency of activity	480 min 5 days per week
Indoor/Outdoor	Indoor
<b>Risk Management Measures</b>	
Local exhaust ventilation	Effectiveness: 90 %
Wear chemically resistant gloves in combination with specific activity training	Effectiveness: 95 %
Provide a good standard of general or controlled ventilation (5 to 10 air changes per hour)	Effectiveness: 70 %
Avoid frequent and direct contact with substance. Supervision in place to check that the RMMs in place are being used correctly and OCs followed. Clean equipment and the work area every day. Ensure minimization of manual phases	
Use suitable chemically resistant gloves., Wear suitable working clothes., Change gloves, if duration of activity exceeds break through time	
Use suitable eye protection.	
<b>Exposure estimate and reference to its source</b>	
Assessment method	EASY TRA v3.5, ECETOC TRA v3.0, Worker
	Worker - dermal, long-term - systemic
Exposure estimate	0.0343 mg/kg bw/day
Risk Characterization Ratio (RCR)	0.004131
Assessment method	EASY TRA v3.5, ECETOC TRA v3.0, Worker
	Worker - inhalation, long-term - local
Exposure estimate	0.7662 mg/m <sup>3</sup>
Risk Characterization Ratio (RCR)	0.766162
<b>Guidance to Downstream Users</b>	
For scaling see: <a href="http://www.ecetoc.org/tra">http://www.ecetoc.org/tra</a>	
<b>Contributing exposure scenario</b>	
<b>Use descriptors covered</b>	PROC4: Chemical production where opportunity for exposure arises Use domain: industrial
<b>Operational conditions</b>	
Concentration of the substance	3,3'-[Butane-1,4-diylbis(oxy)]bispropanamine Content: >= 0 % - <= 100 %

BASF Safety data sheet according to Regulation UK SI 2019/758 and UK SI 2020/1577 as amended from time to time.

Date / Revised: 15.12.2022

Version: 11.0

Date previous version: 29.03.2022

Previous version: 10.0

Date / First version: 08.08.2002

Product: **Baxxodur® EC 280**

(ID no. 30340659/SDS\_GEN\_GB/EN)

Date of print 26.02.2024

Physical state	liquid
Vapour pressure of the substance during use	0.067 Pa
Process temperature	20 °C
Duration and Frequency of activity	240 min 5 days per week
Indoor/Outdoor	Indoor
<b>Risk Management Measures</b>	
Local exhaust ventilation	Effectiveness: 90 %
Wear chemically resistant gloves in combination with specific activity training	Effectiveness: 95 %
Provide a good standard of general or controlled ventilation (5 to 10 air changes per hour)	Effectiveness: 70 %
Avoid frequent and direct contact with substance. Supervision in place to check that the RMMs in place are being used correctly and OCs followed. Clean equipment and the work area every day. Ensure minimization of manual phases	
Use suitable chemically resistant gloves., Wear suitable working clothes., Change gloves, if duration of activity exceeds break through time	
Use suitable eye protection.	
<b>Exposure estimate and reference to its source</b>	
Assessment method	EASY TRA v3.5, ECETOC TRA v3.0, Worker
	Worker - dermal, long-term - systemic
Exposure estimate	0.3429 mg/kg bw/day
Risk Characterization Ratio (RCR)	0.041308
Assessment method	EASY TRA v3.5, ECETOC TRA v3.0, Worker
	Worker - inhalation, long-term - local
Exposure estimate	0.7662 mg/m <sup>3</sup>
Risk Characterization Ratio (RCR)	0.766162
<b>Guidance to Downstream Users</b>	
For scaling see: <a href="http://www.ecetoc.org/tra">http://www.ecetoc.org/tra</a>	

\*\*\*\*\*

## 8. Short title of exposure scenario

Use as an intermediate

SU3; ERC6a; PROC1, PROC2, PROC3

## Control of exposure and risk management measures

Contributing exposure scenario
--------------------------------

BASF Safety data sheet according to Regulation UK SI 2019/758 and UK SI 2020/1577 as amended from time to time.

Date / Revised: 15.12.2022

Version: 11.0

Date previous version: 29.03.2022

Previous version: 10.0

Date / First version: 08.08.2002

Product: **Baxxodur® EC 280**

(ID no. 30340659/SDS\_GEN\_GB/EN)

Date of print 26.02.2024

<b>Use descriptors covered</b>	ERC6a: Use of intermediate	
<b>Operational conditions</b>		
Annual amount used in the EU	5,000 kg	
Minimum emission days per year	20	
Emission factor air	0.01 %	
Emission factor water	0.046 %	
Emission factor soil	0.01 %	
Receive Surf. Water (Flow Rate).	18,000 m3/d	
Dilution factor river	10	
Dilution factor coast	100	
<b>Risk Management Measures</b>		
Air treatment measures considered suitable are, e.g.	Exhaust air scrubber, Waste gas treatment by thermal oxidation	
Wastewater treatment measures considered suitable are, e.g.	Aerobic biological treatment	
Soil treatment measures considered suitable are, e.g.	No application of sludge to soil, Sealing of all relevant soil surfaces	
	No application of sludge to soil	
Type of STP	Municipal STP	
Assumed sewage treatment plant flow (m3/d)	2,000 m3/d	
<b>Exposure estimate and reference to its source</b>		
Assessment method	EASY TRA v4.2, ECETOC TRA v3.0, Environment	
Risk Characterization Ratio (RCR)	0.027105	
	Risk from environmental exposure is driven by marine water.	
Maximum amount of safe use	9,223.3 kg/d	
Risk from environmental exposure is driven by marine water.		
<b>Contributing exposure scenario</b>		
<b>Use descriptors covered</b>	PROC1: Chemical production or refinery in closed process without likelihood of exposure or processes with equivalent containment conditions. Use domain: industrial	
<b>Operational conditions</b>		
Concentration of the substance	3,3'-[Butane-1,4-diylbis(oxy)]bispropanamine Content: >= 0 % - <= 100 %	

BASF Safety data sheet according to Regulation UK SI 2019/758 and UK SI 2020/1577 as amended from time to time.

Date / Revised: 15.12.2022

Version: 11.0

Date previous version: 29.03.2022

Previous version: 10.0

Date / First version: 08.08.2002

Product: **Baxxodur® EC 280**

(ID no. 30340659/SDS\_GEN\_GB/EN)

Date of print 26.02.2024

Physical state	liquid
Vapour pressure of the substance during use	0.067 Pa
Duration and Frequency of activity	480 min 5 days per week
Indoor/Outdoor	Indoor
	Assumes activities are at ambient temperature.
<b>Risk Management Measures</b>	
Provide a good standard of general ventilation (not less than 3 - 5 air changes per hour)	Effectiveness: 30 %
Wear chemically resistant gloves in combination with specific activity training	Effectiveness: 95 %
Avoid frequent and direct contact with substance. Supervision in place to check that the RMMs in place are being used correctly and OCs followed. Clean equipment and the work area every day. Ensure minimization of manual phases	
Use suitable chemically resistant gloves., Wear suitable working clothes., Change gloves, if duration of activity exceeds break through time	
Use suitable eye protection.	
<b>Exposure estimate and reference to its source</b>	
Assessment method	EASY TRA v4.2, ECETOC TRA v3.0, Worker
	Worker - dermal, long-term - systemic
Exposure estimate	0.0017 mg/kg bw/day
Risk Characterization Ratio (RCR)	0.000207
Assessment method	EASY TRA v4.2, ECETOC TRA v3.0, Worker
	Worker - inhalation, long-term - local
Exposure estimate	0.0596 mg/m <sup>3</sup>
Risk Characterization Ratio (RCR)	0.05959
<b>Guidance to Downstream Users</b>	
For scaling see: <a href="http://www.ecetoc.org/tra">http://www.ecetoc.org/tra</a>	
<b>Contributing exposure scenario</b>	
<b>Use descriptors covered</b>	PROC2: Chemical production or refinery in closed continuous process with occasional controlled exposure or processes with equivalent containment conditions Use domain: industrial
<b>Operational conditions</b>	
Concentration of the substance	3,3'-[Butane-1,4-diylbis(oxy)]bispropanamine Content: >= 0 % - <= 100 %

BASF Safety data sheet according to Regulation UK SI 2019/758 and UK SI 2020/1577 as amended from time to time.

Date / Revised: 15.12.2022

Version: 11.0

Date previous version: 29.03.2022

Previous version: 10.0

Date / First version: 08.08.2002

Product: **Baxxodur® EC 280**

(ID no. 30340659/SDS\_GEN\_GB/EN)

Date of print 26.02.2024

Physical state	liquid
Vapour pressure of the substance during use	0.067 Pa
	Air concentration is limited to the saturated air concentration of the pure compound.
Duration and Frequency of activity	480 min 5 days per week
Indoor/Outdoor	Indoor
	Assumes activities are at ambient temperature.
<b>Risk Management Measures</b>	
Local exhaust ventilation	Effectiveness: 90 %
Wear chemically resistant gloves in combination with specific activity training	Effectiveness: 95 %
Provide a good standard of general ventilation (not less than 3 - 5 air changes per hour)	Effectiveness: 30 %
Avoid frequent and direct contact with substance. Supervision in place to check that the RMMs in place are being used correctly and OCs followed. Clean equipment and the work area every day. Ensure minimization of manual phases	
Use suitable chemically resistant gloves., Wear suitable working clothes., Change gloves, if duration of activity exceeds break through time	
Use suitable eye protection.	
<b>Exposure estimate and reference to its source</b>	
Assessment method	EASY TRA v4.2, ECETOC TRA v3.0, Worker
	Worker - dermal, long-term - systemic
Exposure estimate	0.0686 mg/kg bw/day
Risk Characterization Ratio (RCR)	0.008262
Assessment method	EASY TRA v4.2, ECETOC TRA v3.0, Worker
	Worker - inhalation, long-term - local
Exposure estimate	0.5525 mg/m <sup>3</sup>
Risk Characterization Ratio (RCR)	0.552519
<b>Guidance to Downstream Users</b>	
For scaling see: <a href="http://www.ecetoc.org/tra">http://www.ecetoc.org/tra</a>	
<b>Contributing exposure scenario</b>	
<b>Use descriptors covered</b>	PROC3: Manufacture or formulation in the chemical industry in closed batch processes with occasional controlled exposure or processes with equivalent containment condition Use domain: industrial
<b>Operational conditions</b>	

BASF Safety data sheet according to Regulation UK SI 2019/758 and UK SI 2020/1577 as amended from time to time.

Date / Revised: 15.12.2022

Version: 11.0

Date previous version: 29.03.2022

Previous version: 10.0

Date / First version: 08.08.2002

Product: **Baxxodur® EC 280**

(ID no. 30340659/SDS\_GEN\_GB/EN)

Date of print 26.02.2024

Concentration of the substance	3,3'-[Butane-1,4-diylbis(oxy)]bispropanamine Content: >= 0 % - <= 100 %
Physical state	liquid
Vapour pressure of the substance during use	0.067 Pa
	Air concentration is limited to the saturated air concentration of the pure compound.
Duration and Frequency of activity	480 min 5 days per week
Indoor/Outdoor	Indoor
	Assumes activities are at ambient temperature.
<b>Risk Management Measures</b>	
Local exhaust ventilation	Effectiveness: 90 %
Wear chemically resistant gloves in combination with specific activity training	Effectiveness: 95 %
Provide a good standard of general ventilation (not less than 3 - 5 air changes per hour)	Effectiveness: 30 %
Avoid frequent and direct contact with substance. Supervision in place to check that the RMMs in place are being used correctly and OCs followed. Clean equipment and the work area every day. Ensure minimization of manual phases	
Use suitable chemically resistant gloves., Wear suitable working clothes., Change gloves, if duration of activity exceeds break through time	
Use suitable eye protection.	
<b>Exposure estimate and reference to its source</b>	
Assessment method	EASY TRA v4.2, ECETOC TRA v3.0, Worker
	Worker - dermal, long-term - systemic
Exposure estimate	0.0343 mg/kg bw/day
Risk Characterization Ratio (RCR)	0.004131
Assessment method	EASY TRA v4.2, ECETOC TRA v3.0, Worker
	Worker - inhalation, long-term - local
Exposure estimate	0.5525 mg/m <sup>3</sup>
Risk Characterization Ratio (RCR)	0.552519
<b>Guidance to Downstream Users</b>	
For scaling see: <a href="http://www.ecetoc.org/tra">http://www.ecetoc.org/tra</a>	

\*\*\*\*\*

## 9. Short title of exposure scenario

Polymer production, Use as a Process chemical

BASF Safety data sheet according to Regulation UK SI 2019/758 and UK SI 2020/1577 as amended from time to time.

Date / Revised: 15.12.2022

Version: 11.0

Date previous version: 29.03.2022

Previous version: 10.0

Date / First version: 08.08.2002

Product: **Baxxodur® EC 280**

(ID no. 30340659/SDS\_GEN\_GB/EN)

Date of print 26.02.2024

SU3; ERC6d; PROC1, PROC2, PROC3, PROC4, PROC5, PROC7, PROC10, PROC13

### Control of exposure and risk management measures

<b>Contributing exposure scenario</b>	
<b>Use descriptors covered</b>	ERC6d: Use of reactive process regulators in polymerisation processes at industrial site (inclusion or not into/onto article) As no environmental hazard was identified no environmental-related exposure assessment and risk characterization was performed.
<b>Operational conditions</b>	
<b>Contributing exposure scenario</b>	
<b>Use descriptors covered</b>	PROC1: Chemical production or refinery in closed process without likelihood of exposure or processes with equivalent containment conditions. Use domain: industrial
<b>Operational conditions</b>	
Concentration of the substance	3,3'-[Butane-1,4-diylbis(oxy)]bispropanamine Content: >= 0 % - <= 25 %
Physical state	liquid
Vapour pressure of the substance during use	0.067 Pa
Duration and Frequency of activity	480 min 5 days per week
Indoor/Outdoor	Indoor
Assumes activities are at ambient temperature.	
<b>Risk Management Measures</b>	
Provide a good standard of general ventilation (not less than 3 - 5 air changes per hour)	Effectiveness: 30 %
Wear chemically resistant gloves in combination with specific activity training	Effectiveness: 95 %
Avoid frequent and direct contact with substance. Supervision in place to check that the RMMs in place are being used correctly and OCs followed. Clean equipment and the work area every day. Ensure minimization of manual phases	
Use suitable chemically resistant gloves., Wear suitable working clothes., Change gloves, if duration of activity exceeds break through time	
Use suitable eye protection.	

BASF Safety data sheet according to Regulation UK SI 2019/758 and UK SI 2020/1577 as amended from time to time.

Date / Revised: 15.12.2022

Version: 11.0

Date previous version: 29.03.2022

Previous version: 10.0

Date / First version: 08.08.2002

Product: **Baxxodur® EC 280**

(ID no. 30340659/SDS\_GEN\_GB/EN)

Date of print 26.02.2024

<b>Exposure estimate and reference to its source</b>	
Assessment method	EASY TRA v4.2, ECETOC TRA v3.0, Worker
	Worker - dermal, long-term - systemic
Exposure estimate	0.001 mg/kg bw/day
Risk Characterization Ratio (RCR)	0.000124
Assessment method	EASY TRA v4.2, ECETOC TRA v3.0, Worker
	Worker - inhalation, long-term - local
Exposure estimate	0.0358 mg/m <sup>3</sup>
Risk Characterization Ratio (RCR)	0.035754
<b>Guidance to Downstream Users</b>	
For scaling see: <a href="http://www.ecetoc.org/tra">http://www.ecetoc.org/tra</a>	

<b>Contributing exposure scenario</b>	
<b>Use descriptors covered</b>	PROC2: Chemical production or refinery in closed continuous process with occasional controlled exposure or processes with equivalent containment conditions Use domain: industrial
<b>Operational conditions</b>	
Concentration of the substance	3,3'-[Butane-1,4-diylbis(oxy)]bispropanamine Content: >= 0 % - <= 25 %
Physical state	liquid
Vapour pressure of the substance during use	0.067 Pa
Duration and Frequency of activity	480 min 5 days per week
Indoor/Outdoor	Indoor
	Assumes activities are at ambient temperature.
<b>Risk Management Measures</b>	
Local exhaust ventilation	Effectiveness: 90 %
Wear chemically resistant gloves in combination with specific activity training	Effectiveness: 95 %
Provide a good standard of general ventilation (not less than 3 - 5 air changes per hour)	Effectiveness: 30 %
Avoid frequent and direct contact with substance. Supervision in place to check that the RMMs in place are being used correctly and OCs followed. Clean equipment and the work area every day. Ensure minimization of manual phases	
Use suitable chemically resistant gloves., Wear suitable working clothes., Change gloves, if duration of activity exceeds break through time	
Use suitable eye protection.	

BASF Safety data sheet according to Regulation UK SI 2019/758 and UK SI 2020/1577 as amended from time to time.

Date / Revised: 15.12.2022

Version: 11.0

Date previous version: 29.03.2022

Previous version: 10.0

Date / First version: 08.08.2002

Product: **Baxxodur® EC 280**

(ID no. 30340659/SDS\_GEN\_GB/EN)

Date of print 26.02.2024

<b>Exposure estimate and reference to its source</b>	
Assessment method	EASY TRA v4.2, ECETOC TRA v3.0, Worker
	Worker - dermal, long-term - systemic
Exposure estimate	0.0411 mg/kg bw/day
Risk Characterization Ratio (RCR)	0.004957
Assessment method	EASY TRA v4.2, ECETOC TRA v3.0, Worker
	Worker - inhalation, long-term - local
Exposure estimate	0.3575 mg/m <sup>3</sup>
Risk Characterization Ratio (RCR)	0.357542
<b>Guidance to Downstream Users</b>	
For scaling see: <a href="http://www.ecetoc.org/tra">http://www.ecetoc.org/tra</a>	

<b>Contributing exposure scenario</b>	
<b>Use descriptors covered</b>	PROC3: Manufacture or formulation in the chemical industry in closed batch processes with occasional controlled exposure or processes with equivalent containment condition Use domain: industrial
<b>Operational conditions</b>	
Concentration of the substance	3,3'-[Butane-1,4-diylbis(oxy)]bispropanamine Content: >= 0 % - <= 25 %
Physical state	liquid
Vapour pressure of the substance during use	0.067 Pa
	Air concentration is limited to the saturated air concentration of the pure compound.
Duration and Frequency of activity	480 min 5 days per week
Indoor/Outdoor	Indoor
	Assumes activities are at ambient temperature.
<b>Risk Management Measures</b>	
Local exhaust ventilation	Effectiveness: 90 %
Wear chemically resistant gloves in combination with specific activity training	Effectiveness: 95 %
Provide a good standard of general ventilation (not less than 3 - 5 air changes per hour)	Effectiveness: 30 %
Avoid frequent and direct contact with substance. Supervision in place to check that the RMMs in place are being used correctly and OCs followed. Clean equipment and the work area every day. Ensure minimization of manual phases	
Use suitable chemically resistant gloves., Wear suitable working	

BASF Safety data sheet according to Regulation UK SI 2019/758 and UK SI 2020/1577 as amended from time to time.

Date / Revised: 15.12.2022

Version: 11.0

Date previous version: 29.03.2022

Previous version: 10.0

Date / First version: 08.08.2002

Product: **Baxxodur® EC 280**

(ID no. 30340659/SDS\_GEN\_GB/EN)

Date of print 26.02.2024

clothes., Change gloves, if duration of activity exceeds break through time	
Use suitable eye protection.	
<b>Exposure estimate and reference to its source</b>	
Assessment method	EASY TRA v4.2, ECETOC TRA v3.0, Worker
	Worker - dermal, long-term - systemic
Exposure estimate	0.0206 mg/kg bw/day
Risk Characterization Ratio (RCR)	0.002478
Assessment method	EASY TRA v4.2, ECETOC TRA v3.0, Worker
	Worker - inhalation, long-term - local
Exposure estimate	0.5525 mg/m <sup>3</sup>
Risk Characterization Ratio (RCR)	0.552519
<b>Guidance to Downstream Users</b>	
For scaling see: <a href="http://www.ecetoc.org/tra">http://www.ecetoc.org/tra</a>	

<b>Contributing exposure scenario</b>	
<b>Use descriptors covered</b>	PROC4: Chemical production where opportunity for exposure arises Use domain: industrial
<b>Operational conditions</b>	
Concentration of the substance	3,3'-[Butane-1,4-diylbis(oxy)]bispropanamine Content: >= 0 % - <= 25 %
Physical state	liquid
Vapour pressure of the substance during use	0.067 Pa
	Air concentration is limited to the saturated air concentration of the pure compound.
Duration and Frequency of activity	480 min 5 days per week
Indoor/Outdoor	Indoor
	Assumes activities are at ambient temperature.
<b>Risk Management Measures</b>	
Local exhaust ventilation	Effectiveness: 90 %
Wear chemically resistant gloves in combination with specific activity training	Effectiveness: 95 %
Provide a good standard of general ventilation (not less than 3 - 5 air changes per hour)	Effectiveness: 30 %
Avoid frequent and direct contact with substance. Supervision in place to check that the RMMs in place are being used correctly and OCs followed. Clean equipment and the work area every day. Ensure minimization of manual phases	
Use suitable chemically resistant	

BASF Safety data sheet according to Regulation UK SI 2019/758 and UK SI 2020/1577 as amended from time to time.

Date / Revised: 15.12.2022

Version: 11.0

Date previous version: 29.03.2022

Previous version: 10.0

Date / First version: 08.08.2002

Product: **Baxxodur® EC 280**

(ID no. 30340659/SDS\_GEN\_GB/EN)

Date of print 26.02.2024

gloves., Wear suitable working clothes., Change gloves, if duration of activity exceeds break through time	
Use suitable eye protection.	
<b>Exposure estimate and reference to its source</b>	
Assessment method	EASY TRA v4.2, ECETOC TRA v3.0, Worker
	Worker - dermal, long-term - systemic
Exposure estimate	0.2057 mg/kg bw/day
Risk Characterization Ratio (RCR)	0.024785
Assessment method	EASY TRA v4.2, ECETOC TRA v3.0, Worker
	Worker - inhalation, long-term - local
Exposure estimate	0.5525 mg/m <sup>3</sup>
Risk Characterization Ratio (RCR)	0.552519
<b>Guidance to Downstream Users</b>	
For scaling see: <a href="http://www.ecetoc.org/tra">http://www.ecetoc.org/tra</a>	

<b>Contributing exposure scenario</b>	
<b>Use descriptors covered</b>	PROC5: Mixing or blending in batch processes Use domain: industrial
<b>Operational conditions</b>	
Concentration of the substance	3,3'-[Butane-1,4-diylbis(oxy)]bispropanamine Content: >= 0 % - <= 25 %
Physical state	liquid
Vapour pressure of the substance during use	0.067 Pa
	Air concentration is limited to the saturated air concentration of the pure compound.
Duration and Frequency of activity	480 min 5 days per week
Indoor/Outdoor	Indoor
	Assumes activities are at ambient temperature.
<b>Risk Management Measures</b>	
Local exhaust ventilation	Effectiveness: 90 %
Wear chemically resistant gloves in combination with specific activity training	Effectiveness: 95 %
Provide a good standard of general ventilation (not less than 3 - 5 air changes per hour)	Effectiveness: 30 %
Avoid frequent and direct contact with substance. Supervision in place to check that the RMMs in place are being used correctly and OCs followed. Clean equipment and the work area every day. Ensure minimization of manual phases	
Use suitable chemically resistant	

BASF Safety data sheet according to Regulation UK SI 2019/758 and UK SI 2020/1577 as amended from time to time.

Date / Revised: 15.12.2022

Version: 11.0

Date previous version: 29.03.2022

Previous version: 10.0

Date / First version: 08.08.2002

Product: **Baxxodur® EC 280**

(ID no. 30340659/SDS\_GEN\_GB/EN)

Date of print 26.02.2024

gloves., Wear suitable working clothes., Change gloves, if duration of activity exceeds break through time	
Use suitable eye protection.	
<b>Exposure estimate and reference to its source</b>	
Assessment method	EASY TRA v4.2, ECETOC TRA v3.0, Worker
	Worker - dermal, long-term - systemic
Exposure estimate	0.4114 mg/kg bw/day
Risk Characterization Ratio (RCR)	0.04957
Assessment method	EASY TRA v4.2, ECETOC TRA v3.0, Worker
	Worker - inhalation, long-term - local
Exposure estimate	0.5525 mg/m <sup>3</sup>
Risk Characterization Ratio (RCR)	0.552519
<b>Guidance to Downstream Users</b>	
For scaling see: <a href="http://www.ecetoc.org/tra">http://www.ecetoc.org/tra</a>	

<b>Contributing exposure scenario</b>	
<b>Use descriptors covered</b>	PROC5: Mixing or blending in batch processes Use domain: industrial
<b>Operational conditions</b>	
Concentration of the substance	3,3'-[Butane-1,4-diylbis(oxy)]bispropanamine Content: >= 0 % - <= 5 %
Physical state	liquid
Vapour pressure of the substance during use	0.067 Pa
Process temperature	20 °C
Duration and Frequency of activity	240 min 5 days per week
Indoor/Outdoor	Indoor
<b>Risk Management Measures</b>	
Local exhaust ventilation	Effectiveness: 90 %
Wear chemically resistant gloves in combination with specific activity training	Effectiveness: 95 %
Avoid frequent and direct contact with substance. Supervision in place to check that the RMMs in place are being used correctly and OCs followed. Clean equipment and the work area every day. Ensure minimization of manual phases	
Use suitable chemically resistant gloves., Wear suitable working clothes., Change gloves, if duration of activity exceeds break through time	
Use suitable eye protection.	

BASF Safety data sheet according to Regulation UK SI 2019/758 and UK SI 2020/1577 as amended from time to time.

Date / Revised: 15.12.2022

Version: 11.0

Date previous version: 29.03.2022

Previous version: 10.0

Date / First version: 08.08.2002

Product: **Baxxodur® EC 280**

(ID no. 30340659/SDS\_GEN\_GB/EN)

Date of print 26.02.2024

<b>Exposure estimate and reference to its source</b>	
Assessment method	EASY TRA v3.5, ECETOC TRA v3.0, Worker
	Worker - dermal, long-term - systemic
Exposure estimate	0.1371 mg/kg bw/day
Risk Characterization Ratio (RCR)	0.016523
Assessment method	EASY TRA v3.5, ECETOC TRA v3.0, Worker
	Worker - inhalation, long-term - local
Exposure estimate	0.5108 mg/m <sup>3</sup>
Risk Characterization Ratio (RCR)	0.510774
<b>Guidance to Downstream Users</b>	
For scaling see: <a href="http://www.ecetoc.org/tra">http://www.ecetoc.org/tra</a>	

<b>Contributing exposure scenario</b>	
<b>Use descriptors covered</b>	PROC7: Industrial spraying Use domain: industrial
<b>Operational conditions</b>	
Concentration of the substance	3,3'-[Butane-1,4-diylbis(oxy)]bispropanamine Content: >= 0 % - <= 25 %
Physical state	liquid
Vapour pressure of the substance during use	0.067 Pa
Duration and Frequency of activity	480 min 5 days per week
Indoor/Outdoor	Indoor
	Assumes activities are at ambient temperature.
	Large workrooms only
Application rate	< 3 l/min
<b>Risk Management Measures</b>	
Local exhaust ventilation	Effectiveness: 95 %
Wear chemically resistant gloves in combination with specific activity training	Effectiveness: 95 %
Provide a good standard of general ventilation (not less than 3 - 5 air changes per hour)	Effectiveness: 30 %
Ensure that the task is not carried out overhead.	
Surface spraying with no or low compressed air use.	
Provide extract ventilation to points where emissions occur (LEV).	
Ensure that general housekeeping is in place	
Provide a good standard of controlled ventilation (10 to 15 air changes per hour)	
Ensure that the task is being carried	

BASF Safety data sheet according to Regulation UK SI 2019/758 and UK SI 2020/1577 as amended from time to time.

Date / Revised: 15.12.2022

Version: 11.0

Date previous version: 29.03.2022

Previous version: 10.0

Date / First version: 08.08.2002

Product: **Baxxodur® EC 280**

(ID no. 30340659/SDS\_GEN\_GB/EN)

Date of print 26.02.2024

out outside the breathing zone of a worker (distance head-product greater than 1m).	
Avoid frequent and direct contact with substance. Supervision in place to check that the RMMs in place are being used correctly and OCs followed. Clean equipment and the work area every day. Ensure minimization of manual phases	
Use suitable chemically resistant gloves., Wear suitable working clothes., Change gloves, if duration of activity exceeds break through time	
Use suitable eye protection.	
<b>Exposure estimate and reference to its source</b>	
Assessment method	EASY TRA v4.2, ECETOC TRA v3.0, Worker
	Worker - dermal, long-term - systemic
Exposure estimate	1.2857 mg/kg bw/day
Risk Characterization Ratio (RCR)	0.154905
Assessment method	EASY TRA v4.2, Advanced REACH Tool v1.5
	Worker - inhalation, long-term - local
Exposure estimate	0.1 mg/m <sup>3</sup>
Risk Characterization Ratio (RCR)	0.1
<b>Guidance to Downstream Users</b>	
For scaling see: <a href="http://www.ecetoc.org/tra">http://www.ecetoc.org/tra</a> For scaling see: <a href="http://www.advancedreachtool.com">http://www.advancedreachtool.com</a>	
<b>Contributing exposure scenario</b>	
<b>Use descriptors covered</b>	PROC10: Roller application or brushing Use domain: industrial
<b>Operational conditions</b>	
Concentration of the substance	3,3'-[Butane-1,4-diylbis(oxy)]bispropanamine Content: >= 0 % - <= 25 %
Physical state	liquid
Vapour pressure of the substance during use	0.067 Pa
	Air concentration is limited to the saturated air concentration of the pure compound.
Duration and Frequency of activity	480 min 5 days per week
Indoor/Outdoor	Indoor
	Assumes activities are at ambient temperature.
<b>Risk Management Measures</b>	
Local exhaust ventilation	Effectiveness: 90 %
Wear chemically resistant gloves in combination with specific activity training	Effectiveness: 95 %

BASF Safety data sheet according to Regulation UK SI 2019/758 and UK SI 2020/1577 as amended from time to time.

Date / Revised: 15.12.2022

Version: 11.0

Date previous version: 29.03.2022

Previous version: 10.0

Date / First version: 08.08.2002

Product: **Baxxodur® EC 280**

(ID no. 30340659/SDS\_GEN\_GB/EN)

Date of print 26.02.2024

Provide a good standard of general ventilation (not less than 3 - 5 air changes per hour)	Effectiveness: 30 %
Avoid frequent and direct contact with substance. Supervision in place to check that the RMMs in place are being used correctly and OCs followed. Clean equipment and the work area every day. Ensure minimization of manual phases	
Use suitable chemically resistant gloves., Wear suitable working clothes., Change gloves, if duration of activity exceeds break through time	
Use suitable eye protection.	
<b>Exposure estimate and reference to its source</b>	
Assessment method	EASY TRA v4.2, ECETOC TRA v3.0, Worker
	Worker - dermal, long-term - systemic
Exposure estimate	0.8229 mg/kg bw/day
Risk Characterization Ratio (RCR)	0.099139
Assessment method	EASY TRA v4.2, ECETOC TRA v3.0, Worker
	Worker - inhalation, long-term - local
Exposure estimate	0.5525 mg/m <sup>3</sup>
Risk Characterization Ratio (RCR)	0.552519
<b>Guidance to Downstream Users</b>	
For scaling see: <a href="http://www.ecetoc.org/tra">http://www.ecetoc.org/tra</a>	

<b>Contributing exposure scenario</b>	
<b>Use descriptors covered</b>	PROC13: Treatment of articles by dipping and pouring. Use domain: industrial
<b>Operational conditions</b>	
Concentration of the substance	3,3'-[Butane-1,4-diylbis(oxy)]bispropanamine Content: >= 0 % - <= 25 %
Physical state	liquid
Vapour pressure of the substance during use	0.067 Pa
	Air concentration is limited to the saturated air concentration of the pure compound.
Duration and Frequency of activity	480 min 5 days per week
Indoor/Outdoor	Indoor
	Assumes activities are at ambient temperature.
<b>Risk Management Measures</b>	
Local exhaust ventilation	Effectiveness: 90 %
Wear chemically resistant gloves in combination with specific activity training	Effectiveness: 95 %

BASF Safety data sheet according to Regulation UK SI 2019/758 and UK SI 2020/1577 as amended from time to time.

Date / Revised: 15.12.2022

Version: 11.0

Date previous version: 29.03.2022

Previous version: 10.0

Date / First version: 08.08.2002

Product: **Baxxodur® EC 280**

(ID no. 30340659/SDS\_GEN\_GB/EN)

Date of print 26.02.2024

Provide a good standard of general ventilation (not less than 3 - 5 air changes per hour)	Effectiveness: 30 %
Avoid frequent and direct contact with substance. Supervision in place to check that the RMMs in place are being used correctly and OCs followed. Clean equipment and the work area every day. Ensure minimization of manual phases	
Use suitable chemically resistant gloves., Wear suitable working clothes., Change gloves, if duration of activity exceeds break through time	
Use suitable eye protection.	
<b>Exposure estimate and reference to its source</b>	
Assessment method	EASY TRA v4.2, ECETOC TRA v3.0, Worker
	Worker - dermal, long-term - systemic
Exposure estimate	0.4114 mg/kg bw/day
Risk Characterization Ratio (RCR)	0.04957
Assessment method	EASY TRA v4.2, ECETOC TRA v3.0, Worker
	Worker - inhalation, long-term - local
Exposure estimate	0.5525 mg/m <sup>3</sup>
Risk Characterization Ratio (RCR)	0.552519
<b>Guidance to Downstream Users</b>	
For scaling see: <a href="http://www.ecetoc.org/tra">http://www.ecetoc.org/tra</a>	

\*\*\*\*\*

## 10. Short title of exposure scenario

Polymer production, Use as a Process chemical

SU22; ERC8c, ERC8f; PROC10, PROC11, PROC13, PROC14, PROC19

## Control of exposure and risk management measures

<b>Contributing exposure scenario</b>	
<b>Use descriptors covered</b>	ERC6d: Use of reactive process regulators in polymerisation processes at industrial site (inclusion or not into/onto article)
<b>Operational conditions</b>	
Annual amount used in the EU	5,000 kg
Minimum emission days per year	20
Emission factor air	35 %
Emission factor water	0.005 %

BASF Safety data sheet according to Regulation UK SI 2019/758 and UK SI 2020/1577 as amended from time to time.

Date / Revised: 15.12.2022

Version: 11.0

Date previous version: 29.03.2022

Previous version: 10.0

Date / First version: 08.08.2002

Product: **Baxxodur® EC 280**

(ID no. 30340659/SDS\_GEN\_GB/EN)

Date of print 26.02.2024

Emission factor soil	0.025 %
Receive Surf. Water (Flow Rate).	18,000 m3/d
Dilution factor river	10
Dilution factor coast	100
<b>Risk Management Measures</b>	
Soil treatment measures considered suitable are, e.g.	No application of sludge to soil
Type of STP	Municipal STP
Assumed sewage treatment plant flow (m3/d)	2,000 m3/d
<b>Exposure estimate and reference to its source</b>	
Assessment method	EASY TRA v4.2, ECETOC TRA v3.0, Environment
Risk Characterization Ratio (RCR)	0.005392
	Risk from environmental exposure is driven by soil.
Maximum amount of safe use	46,366.6 kg/d
Risk from environmental exposure is driven by soil.	

<b>Contributing exposure scenario</b>	
<b>Use descriptors covered</b>	ERC6d: Use of reactive process regulators in polymerisation processes at industrial site (inclusion or not into/onto article)
<b>Operational conditions</b>	
Annual amount used in the EU	30,000 kg
Minimum emission days per year	20
Emission factor air	35 %
Emission factor water	0.005 %
Emission factor soil	0.025 %
Receive Surf. Water (Flow Rate).	18,000 m3/d
Dilution factor river	10
Dilution factor coast	100
<b>Risk Management Measures</b>	
Soil treatment measures considered suitable are, e.g.	No application of sludge to soil
Type of STP	Municipal STP
Assumed sewage treatment plant flow (m3/d)	2,000 m3/d
<b>Exposure estimate and reference to its source</b>	
Assessment method	EASY TRA v4.2, ECETOC TRA v3.0, Environment

BASF Safety data sheet according to Regulation UK SI 2019/758 and UK SI 2020/1577 as amended from time to time.

Date / Revised: 15.12.2022

Version: 11.0

Date previous version: 29.03.2022

Previous version: 10.0

Date / First version: 08.08.2002

Product: **Baxxodur® EC 280**

(ID no. 30340659/SDS\_GEN\_GB/EN)

Date of print 26.02.2024

Risk Characterization Ratio (RCR)	0.02847
	Risk from environmental exposure is driven by soil.
Maximum amount of safe use	52,686.6 kg/d
Risk from environmental exposure is driven by soil.	

<b>Contributing exposure scenario</b>	
<b>Use descriptors covered</b>	PROC10: Roller application or brushing Use domain: professional
<b>Operational conditions</b>	
Concentration of the substance	3,3'-[Butane-1,4-diylbis(oxy)]bispropanamine Content: >= 0 % - <= 5 %
Physical state	liquid
Vapour pressure of the substance during use	0.067 Pa
Process temperature	20 °C
Duration and Frequency of activity	60 min 5 days per week
Indoor/Outdoor	Indoor
<b>Risk Management Measures</b>	
Local exhaust ventilation	Effectiveness: 80 %
Wear chemically resistant gloves in combination with 'basic' employee training.	Effectiveness: 90 %
Provide a good standard of general ventilation (not less than 3 - 5 air changes per hour)	Effectiveness: 30 %
Avoid frequent and direct contact with substance. Supervision in place to check that the RMMs in place are being used correctly and OCs followed. Clean equipment and the work area every day. Ensure minimization of manual phases	
Use suitable chemically resistant gloves., Wear suitable working clothes., Change gloves, if duration of activity exceeds break through time	
Use suitable eye protection.	
<b>Exposure estimate and reference to its source</b>	
Assessment method	EASY TRA v3.5, ECETOC TRA v3.0, worker, modified version, The duration of activity has been considered using a linear approach.
	Worker - dermal, long-term - systemic
Exposure estimate	0.0686 mg/kg bw/day

BASF Safety data sheet according to Regulation UK SI 2019/758 and UK SI 2020/1577 as amended from time to time.

Date / Revised: 15.12.2022

Version: 11.0

Date previous version: 29.03.2022

Previous version: 10.0

Date / First version: 08.08.2002

Product: **Baxxodur® EC 280**

(ID no. 30340659/SDS\_GEN\_GB/EN)

Date of print 26.02.2024

Risk Characterization Ratio (RCR)	0.008262
Assessment method	EASY TRA v3.5, ECETOC TRA v3.0, worker, modified version, The duration of activity has been considered using a linear approach.
	Worker - inhalation, long-term - local
Exposure estimate	0.7449 mg/m <sup>3</sup>
Risk Characterization Ratio (RCR)	0.744879
<b>Guidance to Downstream Users</b>	
For scaling see: <a href="http://www.ecetoc.org/tra">http://www.ecetoc.org/tra</a> Please note that a modified version has been used (see exposure estimates)	

<b>Contributing exposure scenario</b>	
<b>Use descriptors covered</b>	PROC11: Non industrial spraying Use domain: professional
<b>Operational conditions</b>	
Concentration of the substance	3,3'-[Butane-1,4-diylbis(oxy)]bispropanamine Content: >= 0 % - <= 50 %
Physical state	liquid
Vapour pressure of the substance during use	0.067 Pa
Process temperature	20 °C
Duration and Frequency of activity	480 min 5 days per week
Indoor/Outdoor	Indoor
<b>Risk Management Measures</b>	
Local exhaust ventilation	Effectiveness: >= 50 %
Wear chemically resistant gloves in combination with 'basic' employee training.	Effectiveness: 90 %
Surface spraying with no or low compressed air use. Ensure that the task is not carried out overhead. Ensure that the task is being carried out outside the breathing zone of a worker (distance head-product greater than 1m). Avoid frequent and direct contact with substance. Supervision in place to check that the RMMs in place are being used correctly and OCs followed. Clean equipment and the work area every day. Ensure minimization of manual phases	
Use suitable chemically resistant gloves., Wear suitable working clothes., Change gloves, if duration of activity exceeds break through time	

BASF Safety data sheet according to Regulation UK SI 2019/758 and UK SI 2020/1577 as amended from time to time.

Date / Revised: 15.12.2022

Version: 11.0

Date previous version: 29.03.2022

Previous version: 10.0

Date / First version: 08.08.2002

Product: **Baxxodur® EC 280**

(ID no. 30340659/SDS\_GEN\_GB/EN)

Date of print 26.02.2024

Use suitable eye protection.	
<b>Exposure estimate and reference to its source</b>	
Assessment method	EASY TRA v3.5, ECETOC TRA v3.0, worker, modified version, The concentration of the substance has been considered using a linear approach.
	Worker - dermal, long-term - systemic
Exposure estimate	5.3571 mg/kg bw/day
Risk Characterization Ratio (RCR)	0.645439
Assessment method	EASY TRA v3.5, Advanced REACH Tool v1.5
	Worker - inhalation, long-term - local
Exposure estimate	0.14 mg/m <sup>3</sup>
Risk Characterization Ratio (RCR)	0.14
<b>Guidance to Downstream Users</b>	
For scaling see: <a href="http://www.ecetoc.org/tra">http://www.ecetoc.org/tra</a> Please note that a modified version has been used (see exposure estimates)	

<b>Contributing exposure scenario</b>	
<b>Use descriptors covered</b>	PROC13: Treatment of articles by dipping and pouring. Use domain: professional
<b>Operational conditions</b>	
Concentration of the substance	3,3'-[Butane-1,4-diylbis(oxy)]bispropanamine Content: >= 0 % - <= 5 %
Physical state	liquid
Vapour pressure of the substance during use	0.067 Pa
Process temperature	20 °C
Duration and Frequency of activity	180 min 5 days per week
Indoor/Outdoor	Indoor
<b>Risk Management Measures</b>	
Local exhaust ventilation	Effectiveness: 80 %
Wear chemically resistant gloves in combination with 'basic' employee training.	Effectiveness: 90 %
Provide a good standard of general ventilation (not less than 3 - 5 air changes per hour)	Effectiveness: 30 %
Avoid frequent and direct contact with substance. Supervision in place to check that the RMMs in place are being used correctly and OCs followed. Clean equipment and the work area every day. Ensure minimization of manual phases	
Use suitable chemically resistant gloves., Wear suitable working	

BASF Safety data sheet according to Regulation UK SI 2019/758 and UK SI 2020/1577 as amended from time to time.

Date / Revised: 15.12.2022

Version: 11.0

Date previous version: 29.03.2022

Previous version: 10.0

Date / First version: 08.08.2002

Product: **Baxxodur® EC 280**

(ID no. 30340659/SDS\_GEN\_GB/EN)

Date of print 26.02.2024

clothes., Change gloves, if duration of activity exceeds break through time	
Use suitable eye protection.	
<b>Exposure estimate and reference to its source</b>	
Assessment method	EASY TRA v3.5, ECETOC TRA v3.0, worker, modified version, The duration of activity has been considered using a linear approach.
	Worker - dermal, long-term - systemic
Exposure estimate	0.1029 mg/kg bw/day
Risk Characterization Ratio (RCR)	0.012392
Assessment method	EASY TRA v3.5, ECETOC TRA v3.0, worker, modified version, The duration of activity has been considered using a linear approach.
	Worker - inhalation, long-term - local
Exposure estimate	0.8939 mg/m <sup>3</sup>
Risk Characterization Ratio (RCR)	0.893855
<b>Guidance to Downstream Users</b>	
For scaling see: <a href="http://www.ecetoc.org/tra">http://www.ecetoc.org/tra</a> Please note that a modified version has been used (see exposure estimates)	

<b>Contributing exposure scenario</b>	
<b>Use descriptors covered</b>	PROC14: Tableting, compression, extrusion, pelletisation, granulation Use domain: professional
<b>Operational conditions</b>	
Concentration of the substance	3,3'-[Butane-1,4-diylbis(oxy)]bispropanamine Content: >= 0 % - <= 5 %
Physical state	liquid
Vapour pressure of the substance during use	0.067 Pa
Process temperature	20 °C
Duration and Frequency of activity	180 min 5 days per week
Indoor/Outdoor	Indoor
<b>Risk Management Measures</b>	
Local exhaust ventilation	Effectiveness: 80 %
Wear chemically resistant gloves in combination with 'basic' employee training.	Effectiveness: 90 %
Provide a good standard of general ventilation (not less than 3 - 5 air changes per hour)	Effectiveness: 30 %
Avoid frequent and direct contact with substance. Supervision in place to check that the RMMs in place are being used correctly and OCs	

BASF Safety data sheet according to Regulation UK SI 2019/758 and UK SI 2020/1577 as amended from time to time.

Date / Revised: 15.12.2022

Version: 11.0

Date previous version: 29.03.2022

Previous version: 10.0

Date / First version: 08.08.2002

Product: **Baxxodur® EC 280**

(ID no. 30340659/SDS\_GEN\_GB/EN)

Date of print 26.02.2024

followed. Clean equipment and the work area every day. Ensure minimization of manual phases	
Use suitable chemically resistant gloves., Wear suitable working clothes., Change gloves, if duration of activity exceeds break through time	
Use suitable eye protection.	
<b>Exposure estimate and reference to its source</b>	
Assessment method	EASY TRA v3.5, ECETOC TRA v3.0, worker, modified version, The duration of activity has been considered using a linear approach.
	Worker - dermal, long-term - systemic
Exposure estimate	0.0257 mg/kg bw/day
Risk Characterization Ratio (RCR)	0.003098
Assessment method	EASY TRA v3.5, ECETOC TRA v3.0, worker, modified version, The duration of activity has been considered using a linear approach.
	Worker - inhalation, long-term - local
Exposure estimate	0.8939 mg/m <sup>3</sup>
Risk Characterization Ratio (RCR)	0.893855
<b>Guidance to Downstream Users</b>	
For scaling see: <a href="http://www.ecetoc.org/tra">http://www.ecetoc.org/tra</a> Please note that a modified version has been used (see exposure estimates)	

<b>Contributing exposure scenario</b>	
<b>Use descriptors covered</b>	PROC19: Manual activities involving hand contact Use domain: professional
<b>Operational conditions</b>	
Concentration of the substance	3,3'-[Butane-1,4-diylbis(oxy)]bispropanamine Content: >= 0 % - <= 5 %
Physical state	liquid
Vapour pressure of the substance during use	0.067 Pa
Process temperature	20 °C
Duration and Frequency of activity	60 min 5 days per week
Indoor/Outdoor	Indoor
<b>Risk Management Measures</b>	
Local exhaust ventilation	Effectiveness: 80 %
Wear chemically resistant gloves in combination with 'basic' employee training.	Effectiveness: 90 %
Provide a good standard of general ventilation (not less than 3 - 5 air changes per hour)	Effectiveness: 30 %

BASF Safety data sheet according to Regulation UK SI 2019/758 and UK SI 2020/1577 as amended from time to time.

Date / Revised: 15.12.2022

Version: 11.0

Date previous version: 29.03.2022

Previous version: 10.0

Date / First version: 08.08.2002

Product: **Baxxodur® EC 280**

(ID no. 30340659/SDS\_GEN\_GB/EN)

Date of print 26.02.2024

Avoid frequent and direct contact with substance. Supervision in place to check that the RMMs in place are being used correctly and OCs followed. Clean equipment and the work area every day. Ensure minimization of manual phases	
Use suitable chemically resistant gloves., Wear suitable working clothes., Change gloves, if duration of activity exceeds break through time	
Use suitable eye protection.	
<b>Exposure estimate and reference to its source</b>	
Assessment method	EASY TRA v3.5, ECETOC TRA v3.0, worker, modified version, The duration of activity has been considered using a linear approach.
	Worker - dermal, long-term - systemic
Exposure estimate	0.3536 mg/kg bw/day
Risk Characterization Ratio (RCR)	0.042599
Assessment method	EASY TRA v3.5, ECETOC TRA v3.0, worker, modified version, The duration of activity has been considered using a linear approach.
	Worker - inhalation, long-term - local
Exposure estimate	0.7449 mg/m <sup>3</sup>
Risk Characterization Ratio (RCR)	0.744879
<b>Guidance to Downstream Users</b>	
For scaling see: <a href="http://www.ecetoc.org/tra">http://www.ecetoc.org/tra</a> Please note that a modified version has been used (see exposure estimates)	

\*\*\*\*\*

**APPENDIX IV  
ISO 14001 CERTIFICATE**

---

# Certificate of Approval

This is to certify that the Management System of:

## Abril Industrial Waxes

Sturmi Way, Village Farm Industrial state, Bridgend, CF33 6BZ, United Kingdom

has been approved by LRQA to the following standards:

**ISO 9001:2015, ISO 14001:2015, ISO 45001:2018**

Approval number(s): ISO 9001 – 00004951, ISO 14001 – 00004950, ISO 45001 – 00004952

**The scope of this approval is applicable to:**

The development, manufacture, packaging, storage and supply of wax based products.

**Paul Graaf**

---

Area Operations Manager, Europe

Issued by: LRQA Limited



**APPENDIX V  
TRADE EFFLUENT CONSENT  
& CORRESPONDENCE**

**Direction N<sup>o</sup> 3 of SW74  
(2018)**

**DWR CYMRU CYFYNGEDIG  
THE WATER INDUSTRY ACT 1991  
NOTICE OF DIRECTION VARYING A CONSENT  
TO DISCHARGE TRADE EFFLUENT INTO A PUBLIC SEWER**

To: **ABRIL INDUSTRIAL WAXES**

The owner and occupier of the trade premises (hereinafter called 'the occupiers'), whose registered office is situated at **Munday Industrial Estate, 58-66 Morley Road, Tonbridge, Kent, TN9 1RP.**

- (1) A consent ("the consent") to discharge trade effluent into the public sewer subject to conditions was issued by **DWR CYMRU CYFYNGEDIG** ("the Undertaker") (or its predecessors) on 30<sup>TH</sup> June 1995 from trade premises at **Abril Industrial Waxes, Unit 17A, Strumi Way, Village Farm Industrial Estate, Pyle, Bridgend, CF33 6BZ.**
- (2) Notices of Direction ("the previous Directions") were given in respect of the said discharge on the **10<sup>th</sup> January 2000, 12<sup>th</sup> October 2012 and 11<sup>th</sup> February 2016** by the Undertaker.
- (3) Except in so far as they are varied by this Direction the conditions and provisions of the Consent and previous Direction shall remain in force and shall apply to the discharge.

The Undertaker hereby gives Notice of its Direction that the conditions attached to the Consent shall be varied with effect from the **13<sup>th</sup> April 2018** by:-

- (I) the revocation of the conditions contained in the Consent, and subsequent directions and;
- (II) the substitution for those conditions of the following conditions.

**DWR CYMRU CYFYNGEDIG** (“the Undertaker”) in the exercise of its powers under Section 121 of the Water Industry Act 1991, and thinking it fit to impose conditions as hereinafter appear, **GIVES ITS CONSENT** to the discharge of trade effluent for the said trade premises into the Undertaker’s public sewers, **SUBJECT TO THE FOLLOWING CONDITIONS AND NOT OTHERWISE**

- (1) The public sewer into which the trade effluent may be discharged is the **225 mm** more particularly identified by means of a line coloured RED drawn on the plan attached hereto and marked “B”.
- (2) The discharge of trade effluent shall be made at the point marked “X” on the said plan and the said trade effluent shall enter into the public sewer shown on the said plan at the point marked “Y” thereon and not otherwise. Further, no connection, linkage, conduit, pipe, channel or other communication whatsoever shall be made to the said sewer between the said points “X” and “Y” without the prior approval in writing of the Undertaker.
- (3) The trade effluent to be discharged shall consist solely of that which is specified in the Trade Effluent Notice or application to discharge in respect of which the Consent was given as varied by any application made for the purpose of this Direction and derived exclusively from **Manufacture of Industrial Waxes** .
- (4) Without prejudice to condition 3 above, the nature and/or composition of the trade effluent which may be discharged is as specified in the FIRST SCHEDULE hereto.
- (5) The Trade Effluent shall not include any substances or properties listed in the SECOND SCHEDULE hereto in concentration greater than stated therein.
- (6) The maximum quantity of trade effluent discharged on any day (being any continuous 24 hour period) shall not exceed **1.0** cubic metres.

- (7) The highest rate at which trade effluent may be discharged shall not exceed **1.0** Cubic Metres per hour at a rate of no more than 0.3 Litres per second.
- (8) The trade effluent can be discharged into the public sewer at any time.
- (9) No uncontaminated condensing water shall be discharged.
- (10) There shall be eliminated from the trade effluent before it is discharged the matters listed below:
  - (a) Effluent with a temperature in excess of 43 degrees Celsius (110 degrees Fahrenheit);
  - (b) Petroleum Spirit within the meaning of Section 111 of the Water Industry Act 1991 and/or the Petroleum Act 1928, save as otherwise permitted herein;
  - (c) Other material forming a constituent of the trade effluent, whether alone or in combination with other materials, specified hereby as that which is explosive;
  - (d) Any other substance forming a constituent of the trade effluent which is hereby specified as that which is likely to injure the sewers or to interfere with the free flow of their contents or to affect prejudicially the treatment and disposal of their contents;
  - (e) Any other substance forming a constituent of the trade effluent which is hereby specified as that which in its pure state or in combination with other materials in the contents of the sewer ("the sewage") is capable of producing toxic or flammable vapours.
- (11) No trade effluent shall be discharged the pH value of which is less than **6.0** or greater than **11.0**.
- (12) No trade effluent shall be discharged the nature or composition of which includes a

matter, substance, property or matters, substances or properties which would constitute the trade effluent as Special Category Effluent within the meaning of Section 138 of the Water Industry Act 1991.

- (13) The Occupier shall give to the Undertaker prior written notice of any change in the process of manufacture, materials, or other circumstances howsoever arising capable of altering the nature and/or composition of the trade effluent. No new substances or properties shall be discharged until the Undertaker has agreed thereto, either with or without imposing a limit and thereafter the said substance(s) and/or property(ies) shall be deemed incorporated into the SECOND SCHEDULE.
- (14) An inspection chamber or manhole shall be provided and maintained by the Occupier in a suitable position and/or at the point marked "X" on the plan annexed hereto in connection with each pipe through which the trade effluent is discharged and such inspection chamber or manhole shall be constructed and maintained in accordance with the Undertaker's reasonable requirements as from time to time notified in writing to the occupier so as to enable a person readily at any time to take samples of the trade effluent being discharged.
- (15) A notch gauge, continuous recorder or some other apparatus suitable and adequate to the Undertaker for measuring and automatically recording the volume and rate of trade effluent so discharged shall be provided, such apparatus to be tested and maintained in accordance with the Undertaker's reasonable requirements as from time to time notified in writing to the Occupier.
- (16) Apparatus capable of accurately determining, measuring and recording the nature and/or composition of the trade effluent discharged shall be provided, such apparatus to be tested and maintained in accordance with the Undertaker's reasonable requirements as from time to time notified in writing to the Occupier.
- (17) The Occupier shall keep records of the volume, rate, nature and/or composition of the trade effluent discharged into the sewer at all times available for inspection by any authorised officer of the Undertaker and copies of such records shall be sent to the Undertaker on demand.

- (18) (a) The Occupier shall pay to the Undertaker charges for the reception, conveyance, treatment and disposal of the trade effluent and the costs of sampling, measuring and/or analysis of the same under the Undertaker's trade effluent's functions, which charges shall be determined as set out below, and all sums payable under this condition shall be payable upon demand;
- (b) The charges under (a) above shall be calculated in accordance with Undertaker's Scheme of Charges as from time to time amended;
- (c) For the avoidance of doubt, the charge shall be payable by any person who is or was the Occupier of the said trade premises during the period of discharge of the trade effluent or at the time payment is due.
- (19) If the notch gauge, meter, recorder or other apparatus ceases to record or is suspected of not recording and/or measuring accurately, the quantity of trade effluent discharged into the sewer during the period from the date and/or time at which the records were last accepted by the Undertaker as being correct up to the date when the notch gauge, meter, recorder or other apparatus again registers accurately shall for the purpose of any payment to be made under these conditions be based on the average daily volume of trade effluent discharged during the preceding period over which the records were last accepted by the Undertaker as being accurate or during the month immediately after the notch, gauge, meter, recorder or other apparatus or means of measurement and recording has been accurate whichever is the higher.

## **YOUR RIGHT OF APPEAL**

Section 126 of The Water Industry Act 1991 provides that:-

The Owner or occupier of any trade premises may within 2 months of this Notice of Direction (or with the written permission of the Director General of Water Services at any later time) appeal to the Director against the Direction.

The Director has the power to annul the Direction and to substitute for it any other Direction wherever more or less favourable to the appellant.

The address of the Director for the purpose of an appeal is (Centre City Tower, 7 Hill Street, Birmingham, B5 4UA)

## **FAILURE TO COMPLY WITH CONDITIONS**

If in the case of any trade premises a condition of the Consent or this Direction is contravened, the occupier of the premises will be guilty of an offence and liable on conviction by a Magistrates' Court to a fine not exceeding the statutory maximum or on conviction by the Crown Court to an unlimited fine

## **METHOD OF ANALYSIS**

Compliance with the conditions herewith shall be ascertained by reference to the method of analysis as from time to time employed by the Undertaker, its servants, agents or contractors, save where the said condition(s) otherwise expressly provide(s)

DATED 13<sup>th</sup> February 2018

For and on behalf of the Company

Rob Jenkins

Senior Waste Water Process Scientist SW Wales

Dwr Cymru Cyf  
Pentwyn Road  
Nelson  
Treharris  
Caerphilly

**SCHEDULE ONE**

Nature and composition

The Trade Effluent may contain the following substances:-

1. Water (including such elements, compounds and organisms normally present in water at trace or harmless levels and not exceeding such level as may be imposed by any Regulations for the time being regulating the quality of drinking water).
2. Free and/or emulsified oil and grease
3. Stearic Acid
4. Ethylene bis stearamide
5. Ethylene diamine
6. Monoethanolamine
7. Amine/amide soap of stearic acid .



**SCHEDULE TWO**

1. The chemical oxygen demand of the trade effluent after one hour quiescent settlement at pH 7 shall not exceed 20000 milligrams per litre.
2. Total free and/or emulsified Oils and Grease shall not exceed 150 milligrams per litre.
3. Total suspended solids shall not exceed 400 milligrams per litre.
4. Total ammoniacal nitrogen , (expressed as N ), shall not exceed 1000 milligrams per litre.

**SCHEDULE THREE**

N/A

## **APPENDIX VI SPILLAGE PROCEDURE**



Document type: <b>Procedure</b>	Issue no.: <b>1</b>	Valid from: <b>2023-02-21</b>	ID no.: <b>HOGANAS-998572568-14</b>
Valid for: <b>Abril/Engineering; Abril/Management; Abril/Production</b>			Issuer: <b>Denyer Samantha</b>
Title: <b>Chemical Spillage Procedure</b>			Approver: <b>Denyer Samantha</b>

## Introduction

This procedure outlines the actions to be taken where a chemical spillage is encountered.

## Scope

This procedure covers small, medium and large spillages.

## Definitions

*Small spillage* is defined as a liquid chemical spill of **5 litres or less**

*Medium spillage* is defined as a liquid chemical spill of **more than 5 litres but less than 200 litres**

*Large spillage* is defined as a liquid chemical spill of **more than 200 litres**

*A spillage of EDA over 25 litres is classed as a large spillage.*

## Preliminaries

### Spill kits

Spill kits are stored in the warehouse adjacent to the roller shutter doors and inside the production area beside the fire escape and in WH3 by the fire escape.



Spill kit 1 (Production Warehouse)



Spill kit 2 (Plant)



Spill kit 3 (WH3)



Document type: <b>Procedure</b>	Issue no.: <b>1</b>	Valid from: <b>2023-02-21</b>	ID no.: <b>HOGANAS-998572568-14</b>
Valid for: <b>Abril/Engineering; Abril/Management; Abril/Production</b>			Issuer: <b>Denyer Samantha</b>
Title: <b>Chemical Spillage Procedure</b>			Approver: <b>Denyer Samantha</b>

## Emergency Cupboard

The Emergency cupboard is located in the warehouse adjacent to spill kit 1.



*Emergency Cupboard (Production Warehouse)*



*No smoking sign*



*Wet Floor Sign*

All emergency equipment is subject to regular checks to ensure all necessary items are present and in good working condition.

## **Procedure for Reaction to Spillage**

### **What to do if you locate a spill:**

1. Inform the Shift Supervisor, or nominated deputy, who will co-ordinate the spill control.
2. Assess the size of the spill. Is an evacuation required? Is the fire brigade required? **See section 'Evacuation' on page 3.**
3. Ensure no further entry into the area.

NOTE: If in any doubt that a situation is not normal, get a second opinion.

### **Order of actions:**

1. Protect yourself and others- PPE/ cordon off an area/evacuate
2. Identify what has spilled.
3. Once safe to do so, contain the spill- create a barrier around the spill/ cover drains/ stop the spill at the source.
4. Clean up the spill- use absorbent materials to soak up the spill and once removed clean affected surfaces/equipment.



Document type: <b>Procedure</b>	Issue no.: <b>1</b>	Valid from: <b>2023-02-21</b>	ID no.: <b>HOGANAS-998572568-14</b>
Valid for: <b>Abril/Engineering; Abril/Management; Abril/Production</b>			Issuer: <b>Denyer Samantha</b>
Title: <b>Chemical Spillage Procedure</b>			Approver: <b>Denyer Samantha</b>

- Report the spill to the Operation Manager and on MIA with as much detail as possible. Record waste on 'Abril Hazardous Waste Log'.

### Protecting Yourself

All spills must be considered the 'worst case scenario' until otherwise identified, therefore your PPE should reflect this and assume the spill is EDA until otherwise identified.

As per the PPE matrix PPE required on identification of a spill is:

- full face chemical mask with gas vapour filters (3M 6000 series class 1 full face mask with 3M 6099 gas and vapor filters). Operators must be clean shaven, disposable razors are available in the emergency cupboard.
- type 1 gloves (PVC Chemical gauntlet)
- Chemical suit
- Chemical boots

A work instruction detailing how to 'Don PPE for EDA and other fuming chemicals' is available with a copy on the front of the emergency cupboard.

**Wherever possible you should use your own PPE to ensure the correct size and fit. If it cannot be accessed or is not suitable, PPE from the emergency cupboard or spill kit should be used.**

Once the spill has been identified then PPE can be amended in line with the PPE matrix for the chemical that has spilled, if in doubt do not remove the 'worst case' PPE until the whole process is complete.

### Evacuation

Dependant on the size of the spill, where the spill occurred and if it is suspected to be an EDA, either the area should be evacuated and cordoned off or the whole building should be evacuated.

Small spill of EDA or other fuming materials (<5L) = evacuate the area

Medium/large spill of EDA or other fuming materials (>25L) = evacuate the building

Small (<5L) /medium (5-200L) /large (>200L) spill of non-fuming materials = evacuate the area

Display the 'no smoking or naked flames' sign in the vicinity of the spill. Ensure adequate ventilation by opening doors/windows.

### Identifying the Spill

It is important to know the identity of the material that has spilled so that it can safely be cleaned up. Consider-

The location of the spill and what is used in that area

Is there any packaging in the immediate area?

Is there an odour?



Document type: <b>Procedure</b>	Issue no.: <b>1</b>	Valid from: <b>2023-02-21</b>	ID no.: <b>HOGANAS-998572568-14</b>
Valid for: <b>Abril/Engineering; Abril/Management; Abril/Production</b>			Issuer: <b>Denyer Samantha</b>
Title: <b>Chemical Spillage Procedure</b>			Approver: <b>Denyer Samantha</b>

What colour is the spill?

What consistency is the liquid? Is the liquid solidifying as it cools?

pH papers can be used to identify if the spill is acidic or alkaline, these are attached to the inside lid of the spill kit.

A degree of operator experience will be required for this identification.

### **Containing the Spill**

Consider location-based risks where environmental conditions, hot/cold conditions and naked flames may present a danger.

E.g.

Confined space?

Inside the hot oven?

Beside a drain?

Near the shrink wrap area?

**NOTE:** Fire extinguishers are located around the building, a specific alcohol resistant fire extinguisher is available for use with EDA. EDA vapours can accumulate in low areas and form explosive concentrations.

The size of the spill will determine the procedure for tackling it:

### ***Small spillage***

1. Assess the spillage – what is the chemical? How much is spilled? Where is the spill coming from? Can the spill be stopped?
2. Put on PPE ('worst case' PPE until otherwise identified)
3. Stop the spill at the source by righting overturned containers, closing/plugging a valve or isolating a line etc.
4. Prevent liquids entering the drain using drain covers and by creating a barrier using socks/booms from the spill kit.
5. Ensure adequate ventilation in the area by opening doors and windows.
6. Display the 'no smoking or naked flames' sign to ensure no ignition risk in the area.
7. Contain the spillage with materials from the spill kit (see appendix 2)
8. Clean the spillage using absorbent material from the spill kit.
9. Using a dustpan and brush collect the absorbent granules into a hazardous waste bag and add any other soiled absorbents. Cable tie the bag, swan necking if possible, and store in a suitable container as per work instruction 'Waste and Recycling' HOGANAS-998572568-4.
10. Clean the floor using plenty of warm water (see section below). Display a 'wet floor' sign until there is no longer a slip hazard. A degreaser may be required dependent on material, refer to the material MSDS for details.



Document type: <b>Procedure</b>	Issue no.: <b>1</b>	Valid from: <b>2023-02-21</b>	ID no.: <b>HOGANAS-998572568-14</b>
Valid for: <b>Abril/Engineering; Abril/Management; Abril/Production</b>			Issuer: <b>Denyer Samantha</b>
Title: <b>Chemical Spillage Procedure</b>			Approver: <b>Denyer Samantha</b>

11. Report the spill to the Operation Manager and onto MIA. Report waste onto the 'Abril Hazardous Waste Log'.

### **Medium/Large spillage/spillage**

1. Assess the spillage – what is the chemical? How much is spilled? Where is the spill coming from? Can the spill be stopped?
2. **WHERE THE SUBSTANCE IS EDA AND THE QUANTITY IS OVER 25 LITRES THE FIRE MARSHALL MUST BE INFORMED – THE FIRE AND RESCUE SERVICE MUST BE INFORMED OF THIS SPILLAGE**
3. Notify the Shift Supervisor or their deputy (the Shift Supervisor is the Fire Marshall)
4. Evacuate the area or building, ask for help from others if required. [See section 'Evacuation' on page 2.](#)
5. Put on PPE ('worst case' PPE until otherwise identified)
6. Stop the spill at the source by righting overturned containers, closing/plugging a valve or isolating a line etc.
7. Prevent liquids entering the drain using drain covers and by creating a barrier using socks/booms from the spill kit.
8. Ensure adequate ventilation in the area by opening doors and windows.
9. Display a 'no smoking or naked flames' sign to ensure no ignition risks in the area.
10. Contain the spillage with materials from the spill kit (see appendix 2)
11. Once the spill is no longer active and spreading, clean the spillage using absorbent materials from the spill kit.
12. Using a dustpan and brush collect the absorbent granules into a hazardous waste bag and add any other soiled absorbents. Cable tie the bag, swan necking if possible, and store in a suitable container as per work instruction 'Waste and Recycling' HOGANAS-998572568-4.
13. Clean the floor using plenty of warm water (see section below). Display a 'wet floor' sign until there is no longer a slip hazard. A degreaser may be required dependent on material, refer to the material MSDS for details.
14. Report the spill to the Operation Manager and onto MIA. Report waste onto the 'Abril Hazardous Waste Log'.

### **Cleaning Up After a Spill:**

Once the spill has all been absorbed use the dustpan and brush within the spill kit to clean up absorbent granules. If necessary, replace sodden absorbents with new and repeat until there is no spillage remaining. Collect all absorbent materials in a hazardous waste bags and cable tie the bag, swan necking if possible, store the hazardous waste bags in a suitable container as per work instruction 'Waste and Recycling' HOGANAS-998572568-4.



Document type: <b>Procedure</b>	Issue no.: <b>1</b>	Valid from: <b>2023-02-21</b>	ID no.: <b>HOGANAS-998572568-14</b>
Valid for: <b>Abril/Engineering; Abril/Management; Abril/Production</b>			Issuer: <b>Denyer Samantha</b>
Title: <b>Chemical Spillage Procedure</b>			Approver: <b>Denyer Samantha</b>

Mop the floor with a new mop head using warm water. No detergent is necessary. Use fresh lots of water until no residue remains. A degreaser may be required dependent on material, refer to the material MSDS for details. Dispose of the mop head with the absorbents. All washings must be treated as hazardous waste, collect all washings in a suitable receptacle as per work instruction 'Waste and Recycling' HOGANAS-998572568-4. for hazardous waste disposal.

Wipe down any surfaces/ handles using blue roll or absorbent pads and warm water that could have become contaminated during the clean-up process. These materials must then be disposed of with the absorbent waste.

Solid and liquid waste must be kept separate. Ensure all waste containers are clearly labelled.

Display the wet floor sign until the area no longer presents a slip hazard.

### **Actions to Take Following a Spill:**

Once all clean-up has been complete:

- Inform the Operation Manager.
- Report to Natural Resource Wales (NRW) and Welsh Waster as appropriate.
- Report the incident on MIA with as much information as possible.
- Report the waste on the 'Abril Hazardous Waste' log stating the approximate quantity and the identity of the spill.
- Ensure all contents of the spill kit and emergency cupboard are replaced and the spill kits re-sealed.
- Access if your PPE requires replacement following exposure to the spill and report to the Purchasing Manager if necessary.



Document type: <b>Procedure</b>	Issue no.: <b>1</b>	Valid from: <b>2023-02-21</b>	ID no.: <b>HOGANAS-998572568-14</b>
Valid for: <b>Abri/Engineering; Abri/Management; Abri/Production</b>			Issuer: <b>Denyer Samantha</b>
Title: <b>Chemical Spillage Procedure</b>			Approver: <b>Denyer Samantha</b>

## Appendix 1 - Flowchart for spillage Response:

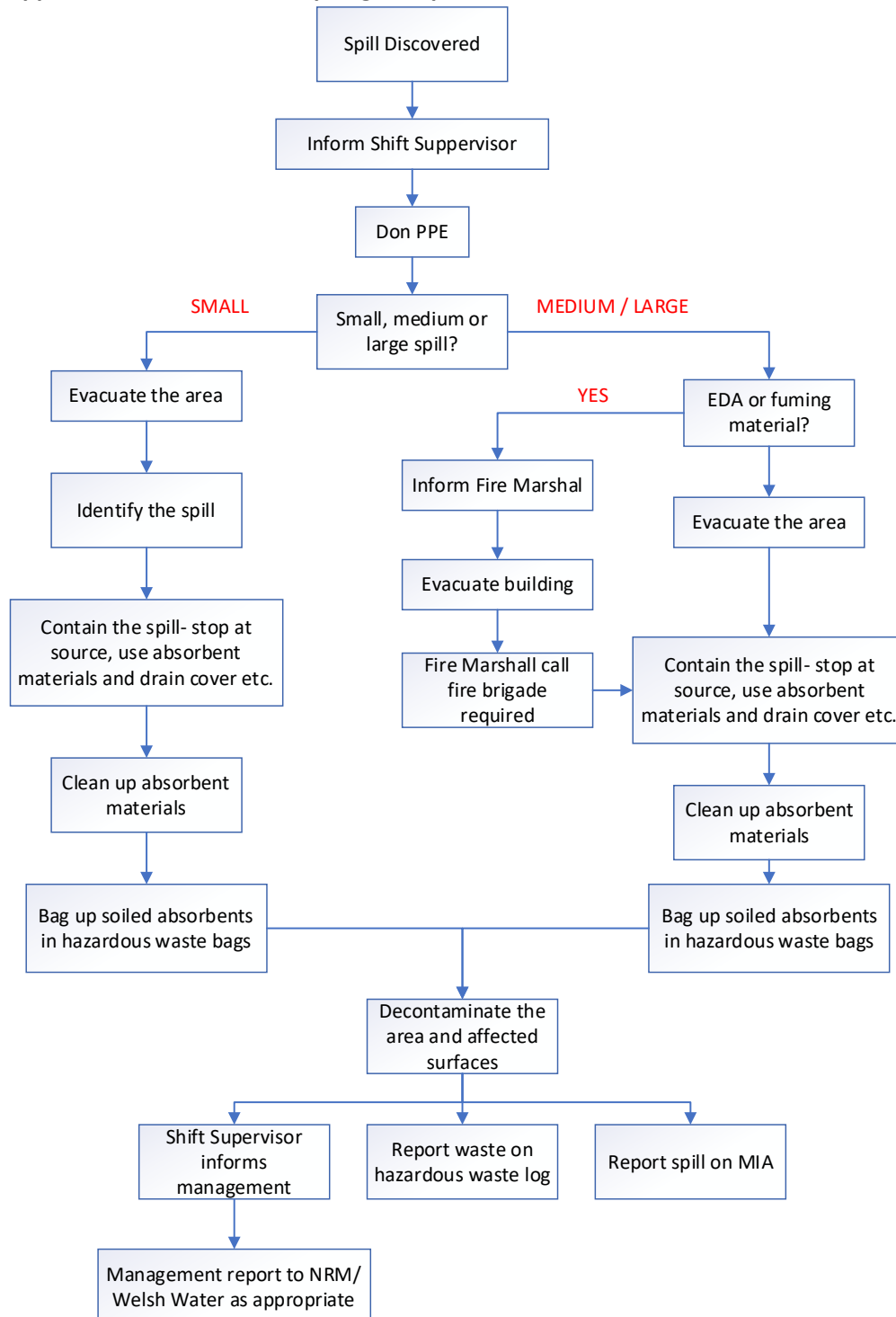



Document type: <b>Procedure</b>	Issue no.: <b>1</b>	Valid from: <b>2023-02-21</b>	ID no.: <b>HOGANAS-998572568-14</b>
Valid for: <b>Abril/Engineering; Abril/Management; Abril/Production</b>			Issuer: <b>Denyer Samantha</b>
Title: <b>Chemical Spillage Procedure</b>			Approver: <b>Denyer Samantha</b>

## Appendix 2-

### Spill Kit absorbent materials and their uses-

Colour coded: General- Grey (can be used to contain any hazardous liquid)  
 Chemical- Yellow (for aggressive chemicals)  
 Oil and Fuel – White (for oils and fuels- water repellent)

**Absorbent Pads-** good for wiping up smaller spills and wiping surfaces



Grey = General Purpose

Yellow = Chemical

**Socks and Booms-** good for containing and absorbing a spill. Booms are larger in diameter than socks and are generally used outside.



Grey = General Purpose

Yellow = Chemical

**Absorbent Cushions-** good for tight spaces or under persistent drips

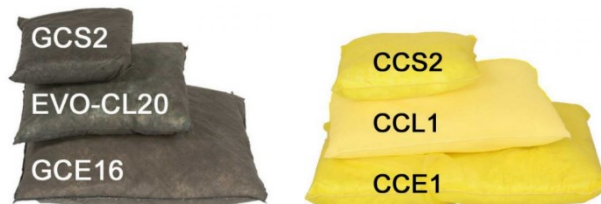

Grey = General Purpose

Yellow = Chemical

**Bagged Absorbent Material-** highly absorbent and good for soaking up spills

**Dammit Paste-** paste that can be used to plug holes in containers

Document type: <b>Procedure</b>	Issue no.: <b>1</b>	Valid from: <b>2023-02-21</b>	ID no.: <b>HOGANAS-998572568-14</b>
Valid for: <b>Abril/Engineering; Abril/Management; Abril/Production</b>			Issuer: <b>Denyer Samantha</b>
Title: <b>Chemical Spillage Procedure</b>			Approver: <b>Denyer Samantha</b>

## Appendix 3- Summary Sheet

1. On identification of the spill alert the Production Supervisor or nominated deputy
2. Evacuate area/ whole building if necessary. Consider location baes risk e.g. confined space, in the oven whilst hot. Display 'no smoking or naked flames' and 'wet floor' signs.



*Wet floor sign*



*no smoking or naked flames sign*

3. Don 'worst case' PPE until spill identified.
  - Full face 3M mask with gas and vapor filters
  - PVC Chemical Suit
  - Chemical boots
  - Type 1 PVC chemical gloves

4. Contain the spill/ stop at source



*drain covers*



*socks/booms*



*pads*



*pillows*



5. Identify the spill based on: location, what materials are in use at time of spill, colour, odour and if necessary, pH papers. **Work instruction 'Use of pH papers for determining pH of a liquid' HOGANAS-807006448-11**
6. Clean up the spill using absorbent materials. Pick up absorbent materials using dustpan and brush in the spill kit. Store all materials in hazardous waste bags within suitable containers for waste disposal as per **work instruction 'Waste and Recycling' HOGANAS-998572568-4.**
7. Report to Operation Manager and on MIA. Report waste on 'Abril Hazardous Waste Log'

**APPENDIX VII  
INCIDENT REPORT FORM**

# Höganäs incident report



Contact:	Dep:	MIA#:
Date:	Site:	

**Background summary:**

**Incident in summary:**

**Containment actions:**

**Causes according to initial assessment:**

**Results of root cause analysis:**

Report to Global Safety Manager within 24 hrs

Report to GSM within  
5 working days

# Höganäs incident report



Contact:	Dep:	MIA#:
Date:	Site:	

Corrective actions:	Resp.:	Deadlines:

Number of lost work days:
---------------------------

**Describing pictures, charts, etc:** (Photos of injured co-workers not to be shared)

Report to Global Safety Manager within 5 working days

# Quick guide for use

- First point of entry for further information
- Date, Department and Site of incident
- Number in MIA

- Short description of the site, the work task, the co-workers(s) and any other background relevant for the incident

- Summary of What, Where, When and Who

- Actions taken to prevent further spread of problem

- Initial assessment of why the incident happened

-----  
End of initial report

- Brief summary of results from root cause analysis

- Number of days of absence from work due to incident

- Decided corrective actions including date of implementation

## Höganäs incident report



Contact:	Dep:	MIA#:
Date:	Site:	

**Background summary:**

**Incident in summary:**

**Containment actions:**

**Causes according to initial assessment:**

**Results of root cause analysis:**

Report to Global Safety Manager within 24 hrs

**Number of lost work days:**

**Describing pictures, charts, etc:** (Photos of injured co-workers not to be shared)

within 5 working days