



Cyfoeth Naturiol Cymru
Natural Resources Wales

Water Resources LICENCE TO

ABSTRACT

WATER

Environment Act 1995
Water Resources Act 1991 as amended
by the Water Act 2003
Water Resources (Abstraction and
Impounding) Regulations 2006
Natural Resources Body for Wales (Functions)
Order 2012

IMPORTANT NOTES

Need for safekeeping

This licence is an important document. The permission or right to abstract water may be valuable to your landholding. So -

- **Keep the licence safe, preferably with your deeds etc.**
- **Take careful note of the comments below about “transfer and apportionment” and “death and bankruptcy”.**

This is to ensure that the permission and any rights granted by the licence continue if you need to pass it on to someone else.

If you want to:

- **revoke (cancel) the licence;**
- **vary (change/amend) the licence in any way or**
- **change your contact address (but you continue to hold the licence).**

Please write to us at your local Natural Resources Wales office.

Details of this licence are placed on a register, kept by Natural Resources Wales and open for inspection by the public. The public may also obtain further details about it by virtue of the Environmental Information Information Regulations 2004 (see also Disclosure of Information) except in special cases (for advice please contact us at the address shown on the front page of the licence).

Transfer and apportionment

If you need to pass this licence or any part of it to someone else, you must contact Natural Resources Wales and obtain the appropriate application forms. Temporary licences cannot be transferred or apportioned. The licence holder remains responsible for compliance with the terms of the licence and any charges payable until the licence has been transferred or apportioned.

Death or bankruptcy of the licence holder

If a licence has been ‘vested’ in you, as a result of the death or bankruptcy of the licence holder, please contact Natural Resources Wales in writing, telling us the licence number(s) and the date that the licence vested in you as a personal representative or trustee of the licence holder. This is necessary in order to enable you to subsequently transfer the licence.

‘Vesting’ is the transfer of responsibility and ownership of a licence when an existing licence holder is no longer able to hold the licence either through death or bankruptcy.

You do not have to complete a form, but you must notify us in writing within 15 months of the date of vesting, giving the full names of all personal representatives or trustees and a contact address.

Time limits

Your licence may be subject to a time limit (stated on the front of your licence). All new abstraction licences are legally required to include a time limit. For variations to licences, time limits are added in accordance with our policy.

The duration of a time limit is determined in accordance with our time limiting policy. The time limit is linked to the next or subsequent review of water resources within a Catchment Abstraction Management Strategy (CAMS).

There will be a presumption of renewal providing three tests are met: environmental sustainability is not in question; there is continued justification of need; and water is being used efficiently. Any application for renewal will still be subject to the normal statutory considerations.

If your licence is time limited and you wish to renew it when it expires, you will need to apply for a new licence to replace the existing one. You are advised to submit this application at least three months before it expires. To allow you to give early consideration to this, we will send you a reminder approximately 18 months before the expiry date.

If your licence cannot be renewed, we will endeavour to give at least six years notice. We will also endeavour to give at least six years notice where the licence is likely to be renewed on different terms and will significantly impact upon the use of the licence.

In exceptional circumstances, for example where there are other overriding statutory duties such as the Habitats Regulations, it may not be possible to provide six years notice.

Charges

Unless specifically exempted, we may levy an annual CHARGE for water AUTHORISED to be abstracted by this licence, in accordance with our abstraction charges scheme in force at the time.

The licence may be revoked if charges are not paid.

Quantity and quality of water

You must not abstract more than the quantity specified in the licence.

Natural Resources Wales does not, by issue of this licence or otherwise, in any way guarantee that the source of supply will produce the quantity of water authorised to be abstracted by this licence, nor that the water is fit for its intended use.

The quantity of water authorised for abstraction is given in cubic metres. One cubic metre is approximately 220 gallons.

(The precise conversion is 1 cubic metres = 219.969 gallons).

Source of supply and authorised point of abstraction

You may abstract from the point(s) specified in the licence and from no other points. If you want to add or change the authorised point(s) of abstraction, you must apply to us to vary the licence.

Land on which water is authorised to be used

Where this condition applies, you may only use the water you abstract on the area specified in the licence. You must apply to us to vary the licence if you wish to extend or alter this area or remove it.

Purpose for which water is authorised to be used

You may only use the water for the purpose(s) specified in the licence. You must apply to us to vary the licence if you wish to add to or change the purpose(s).

Offences

Under the Water Resources Act 1991 it is an offence:-

- to abstract water, or cause or permit any other person to abstract water, unless the abstraction is authorised by and in accordance with an abstraction licence, or is subject to an exemption;
 - to do anything to enable abstraction, or to increase abstraction, except in accordance with an abstraction licence or exemption;
 - to fail to comply with the conditions of an abstraction licence.
- Note in particular that it may be a condition of the licence to maintain the meter or other measuring device etc. and failure to do so will be an offence;**
- to interfere with a meter or other device which measures quantities of water abstracted so as to prevent it from measuring correctly;
 - to fail to provide information which we have reasonably required for the purpose of carrying out any of the Natural Resources Wales water resources functions;
 - to knowingly make false statements for the purpose of obtaining a licence or consent or in giving required information.

The requirement for a licence is subject to some exemptions, set out in the Water Resources Act 1991 as amended. If in any doubt as to whether you need a licence, contact us at the address shown at the bottom of the front page of the licence.

Right of appeal

If you are dissatisfied with our decision on your licence application, you may appeal.

If you are in England, you should write to the Secretary of State for the Environment, Food and Rural Affairs, care of The Planning Inspectorate at:
Room 4/19 Eagle Wing,
Temple Quay House,
2 The Square,
Temple Quay,
Bristol,
BS1 6PN.

If you are in Wales, you should write to Welsh Government care of
The Planning Inspectorate at:
Crown Buildings,
Cathays Park,
Cardiff,
CF10 3NQ.

You must serve notice of appeal within 28 days of the date of receipt of this licence (although the Secretary of State and The Welsh Government have power to allow a longer period for serving notice of appeal). See Water Resources Act 1991, section 43.

Disclosure of information

Information about this licence is available in the public Register held by Natural Resources Wales. Members of the public are also entitled to ask us for other “environmental information” it holds, including any activities likely to affect “the state of any water” or any “activities or other measures designed to protect it”. That would include the information additional to the licence document e.g. any related agreement or abstraction returns. In certain restricted circumstances it is possible to claim that information should be kept confidential. If you require more information about keeping this information off the public register because it is confidential, please contact us by writing to the address shown on the front page of the licence within 28 days of receiving this licence.

FULL LICENCE TO ABSTRACT WATER

The Natural Resources Body for Wales (hereafter referred to as “NRW”) grants this licence to:-

Graham Ralph (“the Licence Holder”)

Gwernvale Farm
Brecon Road
Crickhowell
Powys
NP8 1SE

This licence authorises the Licence Holder to abstract water from the source of supply described in the Schedule of Conditions to this licence and subject to the provisions of that Schedule. The licence commences from the effective date shown below and shall remain in force until the date of expiry shown below.

Signed:



Ashley Lansdown
Permitting Team Leader
Permitting Service
Natural Resources Wales
Welsh Government Offices
Cathays Park
King Edward VII Avenue
Cardiff
CF10 3NQ

Date of issue.....05 March 2026
Date effective.....01 April 2026
Date of expiry.....31 March 2038
Date of original issue.....14 March 2012

This licence should be kept safe and its existence disclosed on any sale of the property to which it relates. Please read the ‘important notes’ on the cover to this licence.

Note: References to “the map” are to the map which forms part of this licence.
References to “NRW” are to the Natural Resources Body for Wales or any successor body.

SCHEDULE OF CONDITIONS

1. SOURCE OF SUPPLY

- 1.1 Inland water (stream) known as Unnamed tributary of Cwmbeth Brook at Gwernvale Farm, Crickhowell, Powys.

2. POINT OF ABSTRACTION

- 2.1 At National Grid Reference SO 21480 19763 marked 'Point A' on the map.

3. MEANS OF ABSTRACTION

- 3.1 Intake works equipped with 180 millimetre gravity feed penstock pipe.

4. PURPOSE OF ABSTRACTION

- 4.1 Power production.

5. PERIOD OF ABSTRACTION

- 5.1 All year.

6. MAXIMUM QUANTITIES OF WATER TO BE ABSTRACTED

- 6.1 3,456 cubic metres per day
760,320 cubic metres per year
At an instantaneous rate not exceeding 40 litres per second.

Note: A day means any period of 24 consecutive hours and a year means the 12 month period beginning on 1 April and ending on 31 March.

7. MEANS OF MEASUREMENT OF WATER ABSTRACTED

- 7.1 (i) The Licence Holder shall determine the quantity of water abstracted by reference to the kilowatt-hours generated, as measured by a kilowatt-hours meter multiplied by the conversion factor determined using the calculation checklist attached to this licence.
- (ii) The Licence Holder shall retain supporting documentation relating to details of the methodology and calculations used to convert electricity generated to the quantities abstracted and make them available to NRW on request.

8. RECORDS

- 8.1 (i) The Licence Holder shall record readings of the electrical output and the corresponding quantity of water abstracted at the same time each week, as determined using the calculation checklist attached to this licence or at such other intervals as may be approved by NRW in writing.

- (ii) The Licence Holder shall send to NRW a copy of the records required by (i) above within 28 days after 31 March in each year, and also within 28 days of being so requested in writing by NRW.
- (iii) The Licence Holder shall keep all records for at least 6 years, and shall allow NRW to inspect them during all reasonable hours.

9. FURTHER CONDITIONS

- 9.1 For the purpose of this licence, references to 'hydropower scheme' shall mean all works consisting of a concrete weir equipped with stainless steel intake screen and forebay tank, level sensors, compensation notch, gravity feed penstock pipe, spear valve controller, Turgo turbine and mesh screen situated on the discharge outlet pipe.
- 9.2 The Licence Holder shall construct, operate and maintain the hydropower scheme in accordance with the specifications and drawings:

'10014/02/B' (revised),
'10014/01/B' and;
'10014/04/B'

dated February 2012, copies of which appended to this licence, or such minor amendments to those document that are accepted in writing by NRW prior to the date of commencement of construction.
- 9.3 The Licence Holder shall, as far as is reasonably practicable, ensure that no water flows through the turbine if the Licence Holder is unable to generate power.
- 9.4 No abstraction of water shall take place unless the rate of flow in the unnamed tributary of Cwmbeth Brook immediately downstream of the authorised point of abstraction, marked as 'Point A' as specified in Condition 2.1, is equal to or greater than 6 litres per second and the abstraction shall not cause the flow immediately downstream of said abstraction point to fall below that rate.
- 9.5
- (i) No abstraction shall take place unless the Licence Holder has installed a stainless steel intake screen with spacing no greater than 3 millimetres to prevent the entrapment, entrainment or impingement of fish at the point of abstraction.
 - (ii) The Licence Holder shall maintain the fish screen in accordance with the manufacturer's specifications and keep records of such maintenance available for inspection.
- 9.6
- (i) No abstraction shall take place unless the Licence Holder has installed a mesh screen with spacing no greater than 10 millimetres to the discharge outlet pipe to prevent the entrapment, entrainment or impingement of fish.
 - (ii) The Licence Holder shall maintain the mesh screen in accordance with the manufacturer's specifications and keep records of such maintenance available for inspection.

- 9.7 The Licence Holder shall return all of the water abstracted in pursuance of this licence to the unnamed tributary of Cwmbeth Brook at National Grid Reference SO 21481 19593 marked 'Point Q' on the map.

ADDITIONAL INFORMATION

Note: the following information is provided for information only. It does not form part of the licence.

REASONS FOR CONDITIONS

The licence is time-limited to a date to reflect the timing of a future review of the catchment resources availability.

Conditions 7 and 8: the Licence Holder is required to record readings of the electrical output and the corresponding quantity of water abstracted to demonstrate compliance with the conditions of this licence and to provide information on actual water usage for water planning purposes.

Conditions 9.1 and 9.2: to ensure the hydropower scheme is constructed, operated and maintained in accordance with the drawings and specifications agreed by NRW during the determination of the licence.

Condition 9.3: to secure the proper and efficient use of water resources.

Conditions 9.4: to ensure a flow is maintained in the watercourse in order i) to maintain the riverine habitat for the conservation of the flora and fauna.

Condition 9.5: to prevent the entrapment, entrainment and impingement of fish at the point of abstraction.

Condition 9.6: to prevent the entrapment, entrainment and impingement of fish at the point of discharge.

Condition 9.7: to ensure the abstraction can be classed as non-consumptive.

IMPORTANT NOTES

Impoundment licence serial number WA/056/0036/005 has been issued to facilitate the abstraction of water for the hydropower scheme authorised by this abstraction licence.

Condition 9.4: flows will be maintained and controlled by physical means through the design of the impoundment structure authorised by the above numbered licence.

For the purpose of Condition 9.2 the Licence Holder shall contact:

Senior Officer
South East People and Places Team
Natural Resources Wales
Rivers House
St. Mellons Business Park
Fortran Road

Cardiff
CF3 0EY

Tel: 0300 065 3000

Email: nrp.southeast@cyfoethnaturiolcymru.gov.uk

Water efficiency note

The Licence Holder should use water abstracted under the terms of this licence in an efficient manner. NRW may refer to its guidance on water efficiency (or equivalent guidance) in determining whether water is being used efficiently and may offer advice on any measures considered necessary to meet particular recommendations.

Screening

NRW will have regard to its Screening for Intakes and Outfalls: a Best Practice Guide (or equivalent guidance) in agreeing where, how and what type of fish screens should be installed and together with the results of any monitoring in determining whether the fish screens are properly effective and maintained, and in judging whether it is necessary to require repair or replacement of the fish screens.

Licence history

Licence Serial Number	Issue and Effective Date	Expiry Date	Summary of Changes
WA/056/0036/002	14/03/2012	31/03/2026	Original Licence Issued.
WA/056/0036/002/R001	Issued: 05/03/2026 Effective: 01/04/2026	31/03/2038	Licence renewed on same terms.

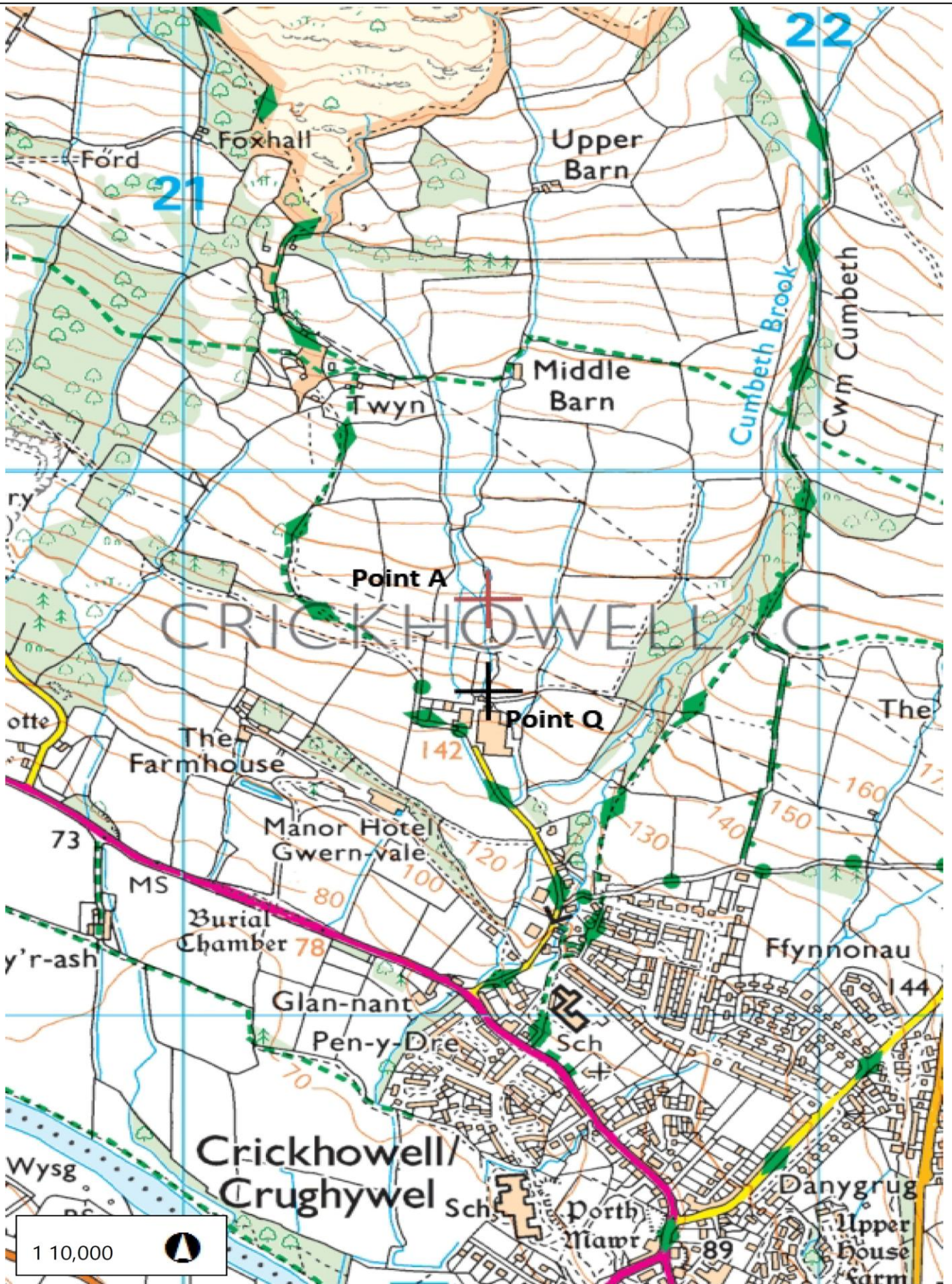

1 10,000 



MAP ACCOMPANYING LICENCE NUMBER / MAP I GYFEILIO TRWYDDED RHIF

WA/056/0036/002/R001

Scale | Graddfa 1:10,000



© Crown Copyright and database rights Ordnance Survey. Natural Resources Wales, 100019741, 2015.
 © Hawlfraint y Goron a hawl cronfa ddata Arolwg Ordnans. Cyfoeth Naturiol Cymru, 100019741, 2015.

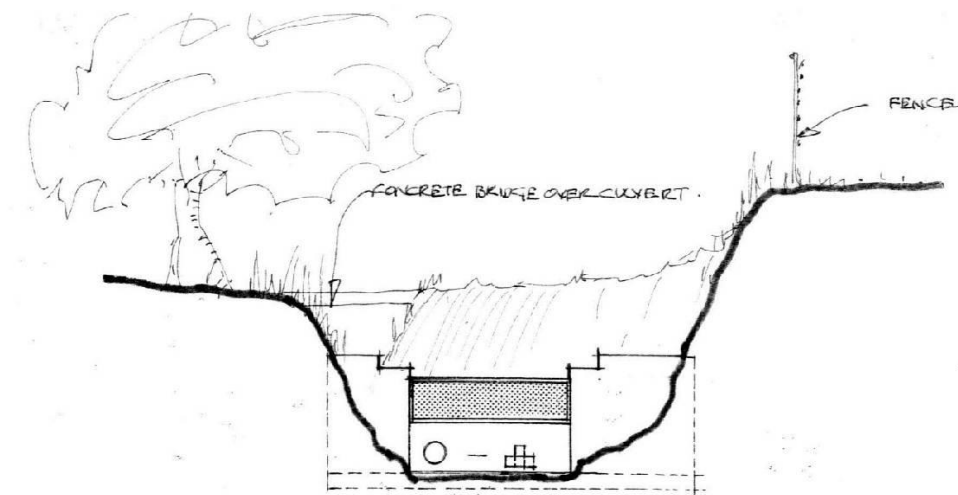

SECTION Y-Y 1:50

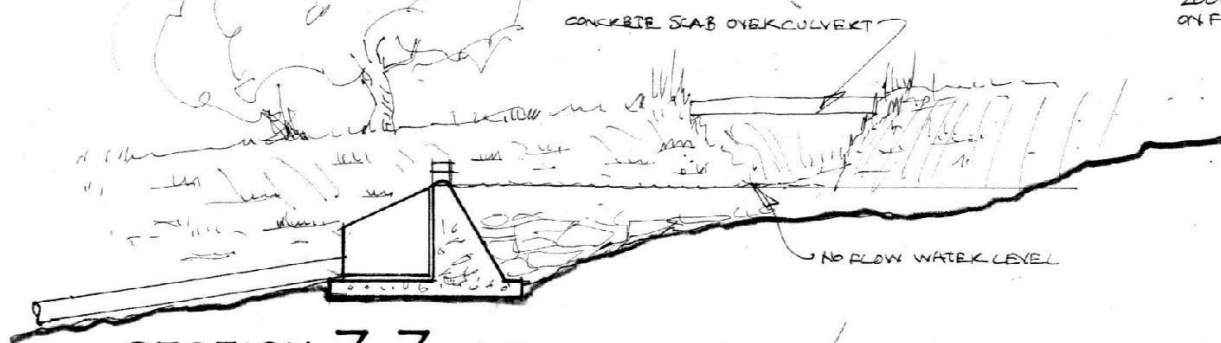

SECTION Z-Z 1:50

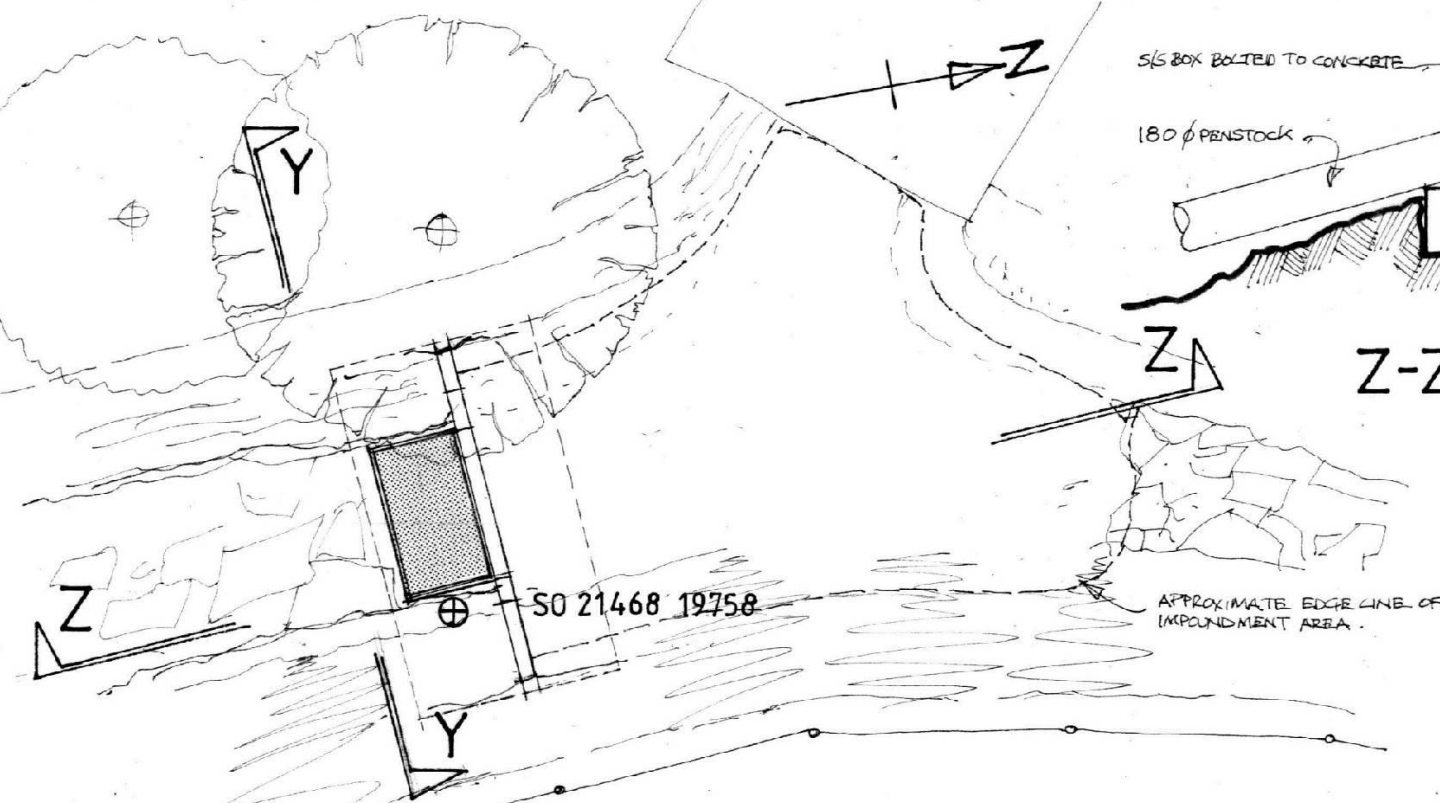

PLAN at INTAKE 1:50

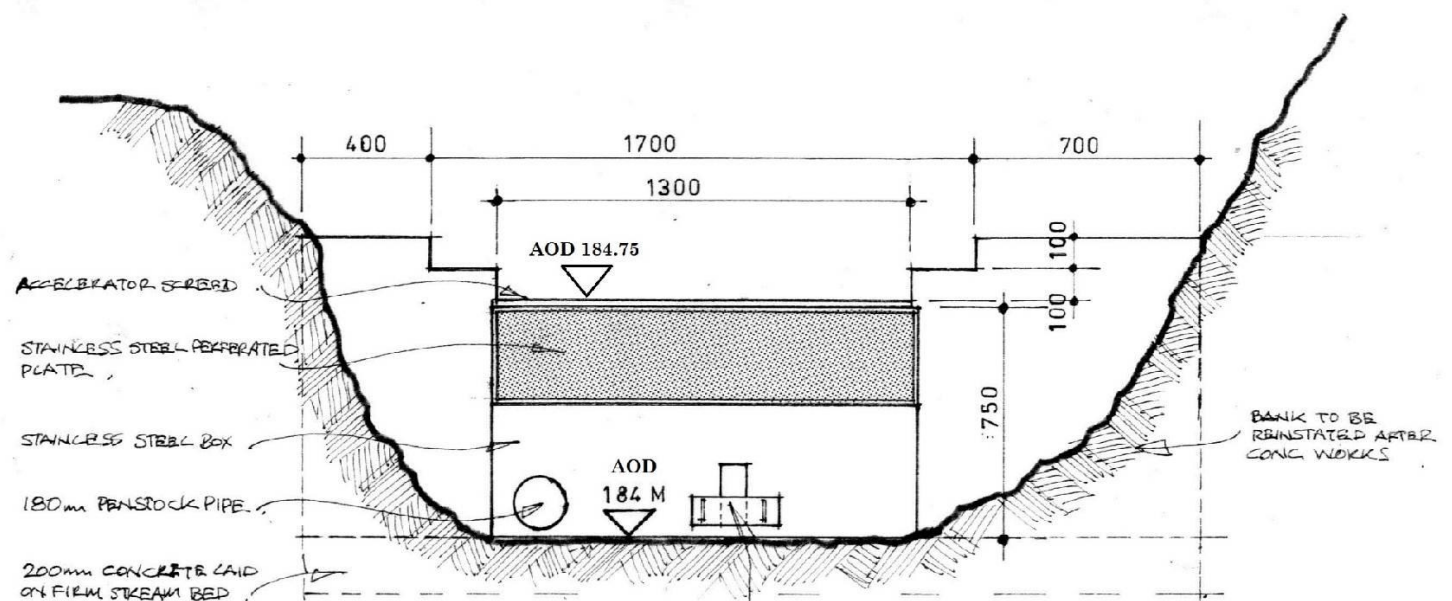

Y-Y 1:20

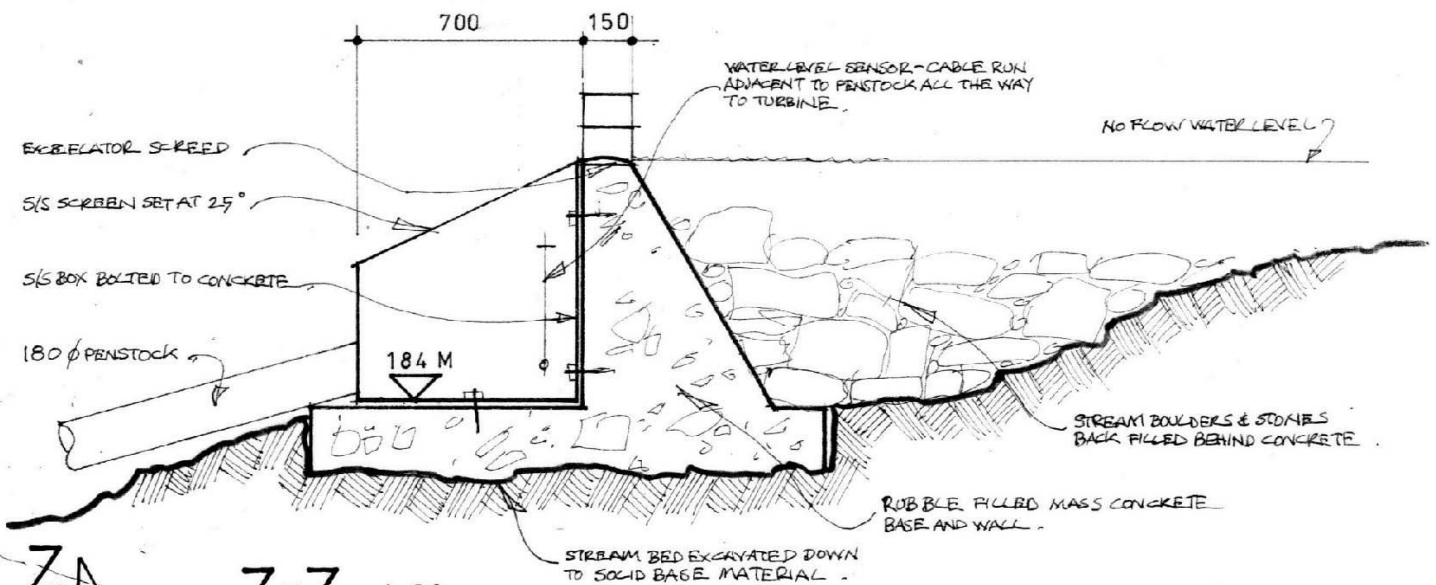

Z-Z 1:20

Proposed hydro installation at Gwernvale House .

Proposed intake details



TGV Hydro Ltd
 CriC
 Beaufort Street
 Crickhowell
 NP8 1BN
 telephone 07969 137719

date February 2012
 scale 1:50 & 1:20
 paper size A3
 drawn by GC
 checked by NW

job number 100/14

drawing no 10014/02/ B

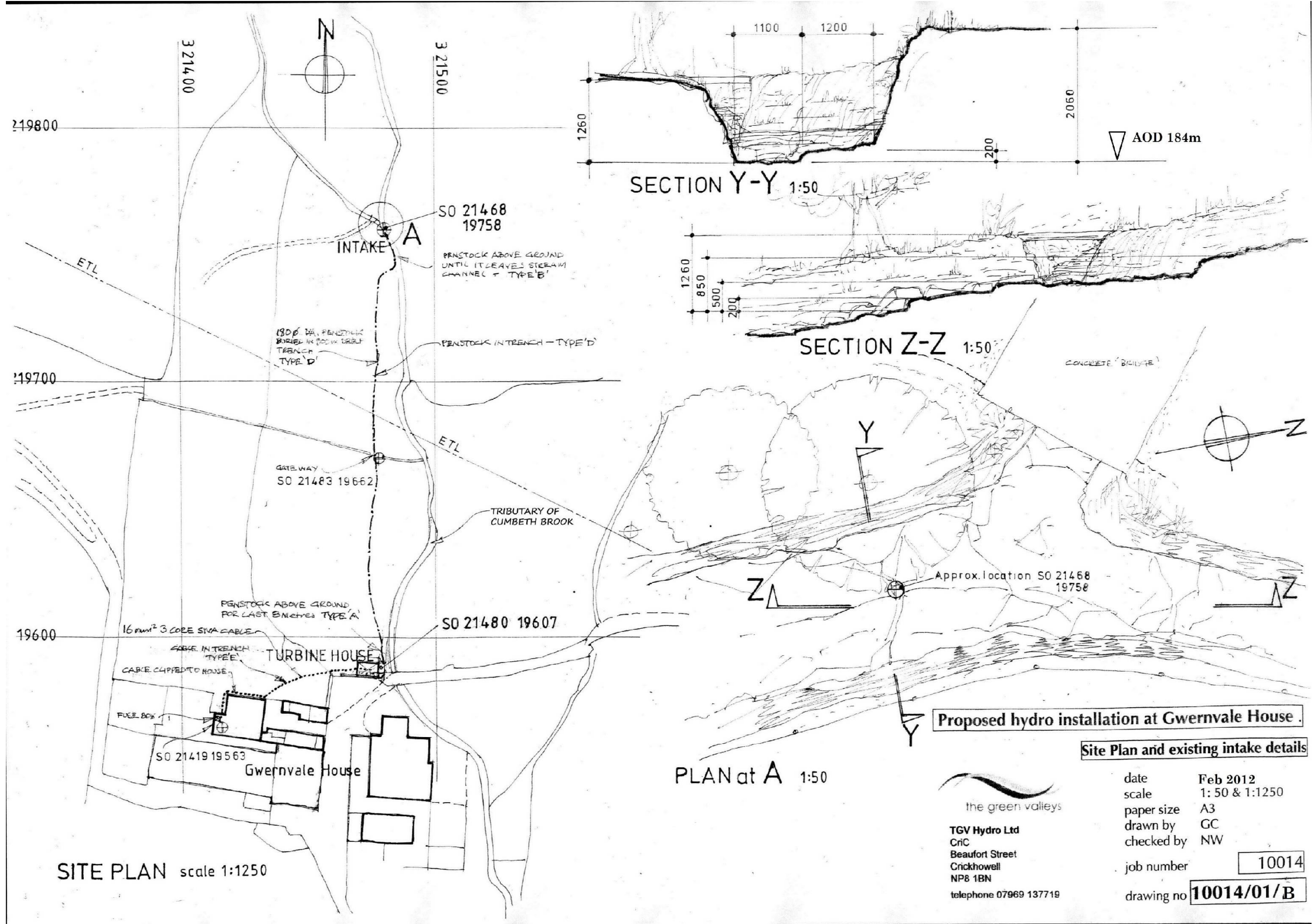

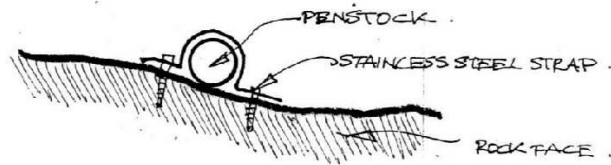

Type A - pipe running along a long length on a hard surface (in or out of stream). Pipe held in place with stainless steel straps drilled into hard surface (could be bed rock or just a large 'immovable' large boulder).

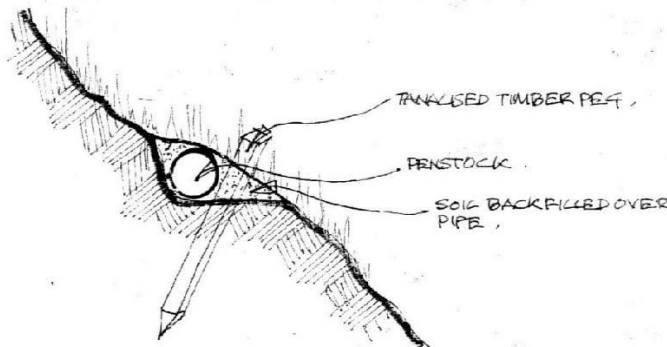

Type B - Pipe running along a long length of soft surface material but across a steep slope. Slope excavated to form 'shelf' upon which the pipe sits. Pipe held with tanalised timber pegs on the down slope side or with Stainless steel hoops. Excavated soil place back over the pipe to fill the gap on the upslope side of the pipe.

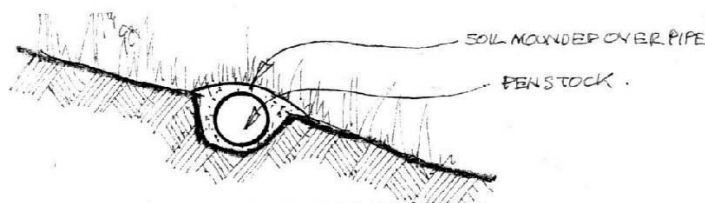

Type C - Pipe running along a long length of soft surface material running down a slope but without a cross slope and in a shallow trench. This will be similar to Type B but pipe 'shelf' will be a shallow trench with a depth of about 60% of the pipe diameter. Excavated soil is then piled up and over the pipe.

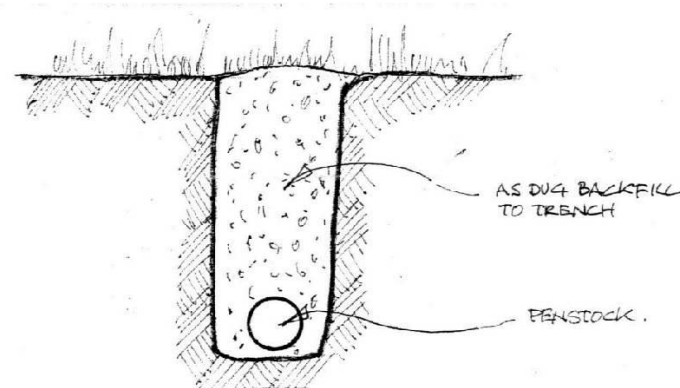

Type D - Pipe running along a long length of soft surface material running down a slope but without a cross slope and in a deeper trench. This like a traditional trench. Back fill to be selected excavated material with no sharp stones adjacent to the pipe. Cover to pipe to be a minimum of 450mm, this may be increased to 1000mm in areas of potential deep ploughing.

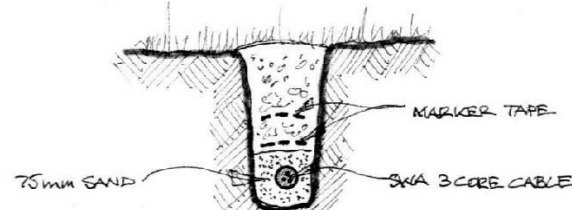

Type E - Cable in trench. 75mm Sand bed and surround. Two layers of marker tape above. Minimum 450mm cover (520mm in roads), this may be increased to 1000mm in areas of potential deep ploughing.

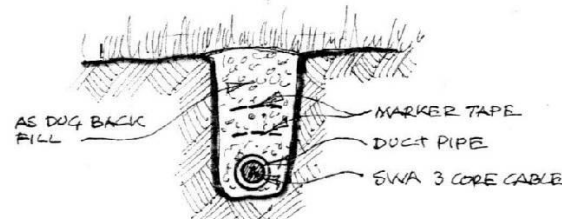

Type F - Cable in duct. Approved smooth bore duct with draw cord and long radius bends. Two layers of marker tape above. Minimum 450mm cover (520mm in roads), this may be increased to 1000mm in areas of potential deep ploughing.

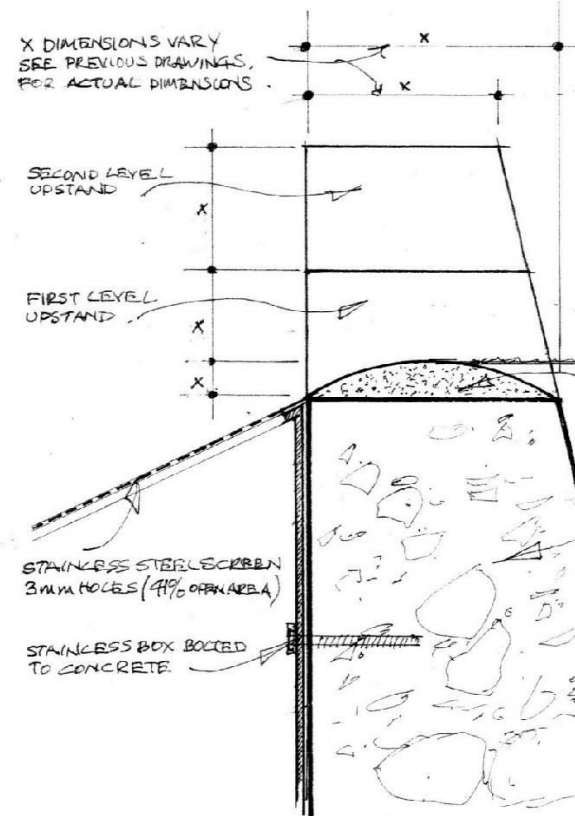

TYPICAL TOP OF WEIR INTAKE DETAIL 1:5

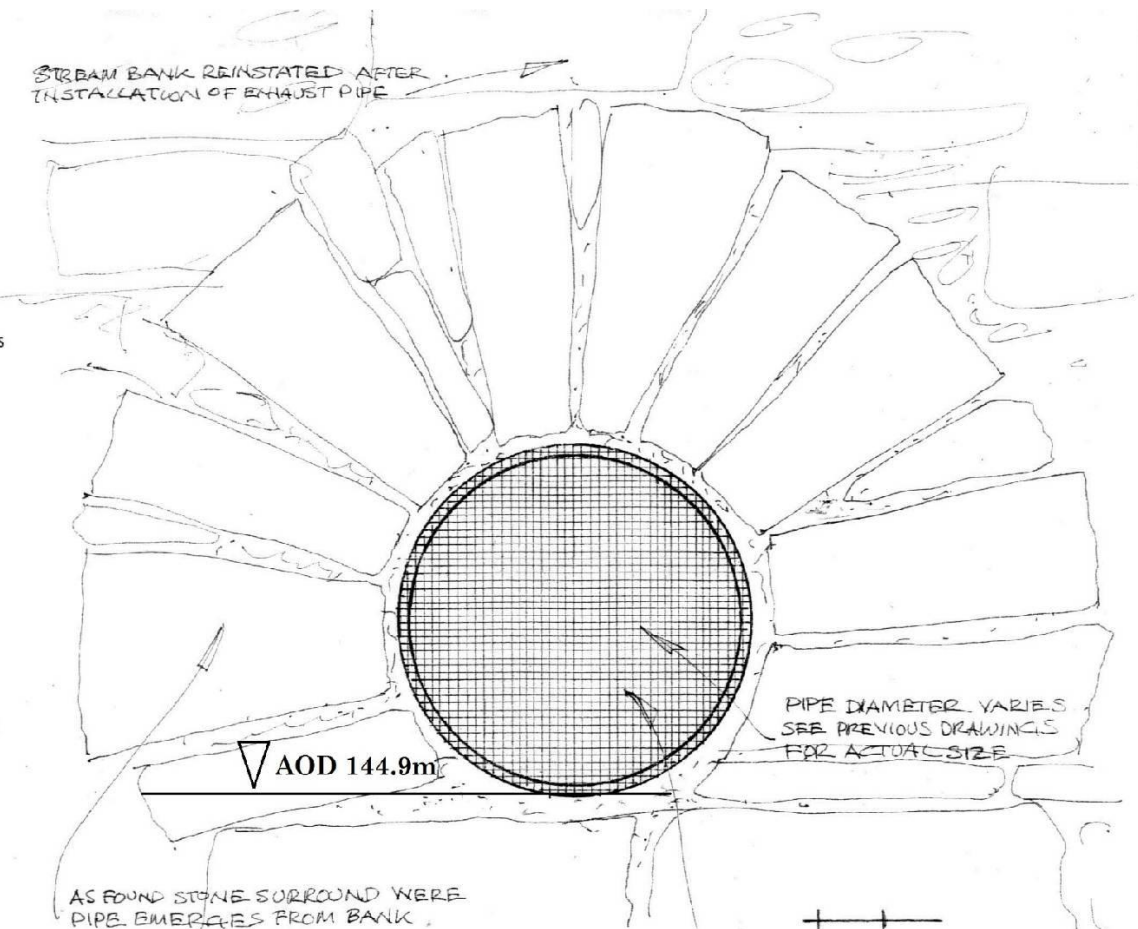

TYPICAL EXHAUST PIPE DETAIL 1:5

STAINLESS STEEL WIRE MESH FITTED OVER EXHAUST PIPE. WIRES AT 10mm CENTRES.

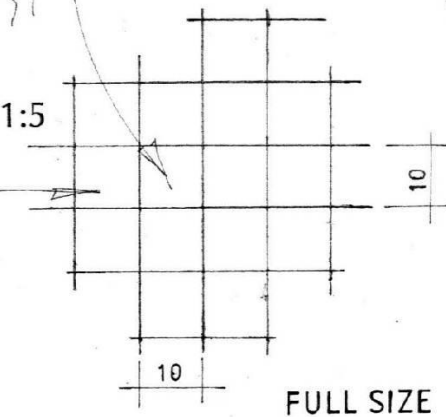

Proposed hydro installation at Gwernvale House.



TGV Hydro Ltd
CrIC
Beaufort Street
Crickhowell
NP8 1BN
telephone 07969 137719

Proposed general details.

date February 2012
scale 1: 20, 1:5
paper size A3
drawn by GC
checked by NW
job number 100/14
drawing no 10014/04/B

Calculation Checklist

This checklist shall be used to record the site data and calculate the Hydro Abstraction Factor for the site (HAF_{site}) to allow conversion of electrical output to quantities abstracted. **The HAF_{site} is the amount of water used in m^3 per kWh generated for any period.**

Site Data	
Site name	
Address	
Licence serial No.	
Contact name	
Contact telephone	
Contact email	
Turbine manufacturer	
Turbine type	
Turbine serial no.	
Number of jets (where relevant)	

Performance Data		
Parameter	Value	How was the parameter determined?
Net operating head of the system at maximum power output ($H_{n(Pmax)}$) in metres		
Turbine/water wheel efficiency at maximum power output ($e_{turbine/water\ wheel(Pmax)}$)		
Transmission system efficiency at maximum power output ($e_{transmission(Pmax)}$)		
Generator efficiency at maximum power output ($e_{generator(Pmax)}$)		

Calculation of overall system efficiency of the rotating parts of the hydro system, at maximum power output ($e_{system(Pmax)}$)

$$e_{system(Pmax)} = e_{turbine/water\ wheel(Pmax)} \times e_{transmission(Pmax)} \times e_{generator(Pmax)}$$

$$= \boxed{} \times \boxed{} \times \boxed{}$$

$$e_{system(Pmax)} = \boxed{}$$

Calculation of HAF_{site}

HAF_{site} = Hydro Abstraction Factor for the site in question

$$= 366.972 / (H_{n(Pmax)} \times e_{system(Pmax)})$$

$$= 366.972 / (\boxed{} \times \boxed{})$$

$$= \boxed{} \quad (\mathbf{m^3/kWh})$$

Where:

$H_{n(Pmax)}$ = net head at max. power.

366.972 = a constant in order to bring the final HAF into the correct unit of $m^3/kWhr$ (it is arrived at by dividing the number of seconds in an hour (3600) by gravity (9.81 m/s^2))

The volume of water abstracted for any period (V_{period}) can then be calculated by simply multiplying the HAF_{site} by the number of kiloWatt hours generated thus:

$$V_{period} (m^3) = kWh_{period} (kWh) \times HAF_{site} (m^3/kWh)$$

See example:

(kWh is a measure of energy, whilst kW is a measure of power: at full efficiency, a 50 kW

turbine will produce 50 kWh of energy in one hour, 100 kWh in two hours, 150 kWh in three hours etc.).

Performance Data		
Parameter	Value	How was the parameter determined?
Net operating head of the system at maximum power output ($H_{n(Pmax)}$) in metres	150	Site survey
Turbine/water wheel efficiency at maximum power output ($e_{turbine/water\ wheel(Pmax)}$)	0.9	From manufacturer
Transmission system efficiency at maximum power output ($e_{transmission(Pmax)}$)	0.85	From manufacturer
Generator efficiency at maximum power output ($e_{generator(Pmax)}$)	0.85	From manufacturer

Calculation of overall system efficiency of the rotating parts of the hydro system, at maximum power output ($e_{system(Pmax)}$)

$$e_{system(Pmax)} = e_{turbine/water\ wheel(Pmax)} \times e_{transmission(Pmax)} \times e_{generator(Pmax)}$$

$$= \boxed{0.9} \times \boxed{0.85} \times \boxed{0.85}$$

$$e_{system(Pmax)} = \boxed{0.65}$$

Calculation of HAF_{site}

HAF_{site} = Hydro Abstraction Factor for the site in question

$$= 366.972 / (H_{n(Pmax)} \times e_{system(Pmax)})$$

$$= 366.972 / (\boxed{150} \times \boxed{0.65})$$

$$= \boxed{3.764} \quad (\text{m}^3/\text{kWh})$$

The volume of water abstracted for any period (V_{period}) can then be calculated by simply multiplying the HAF_{site} by the number of kiloWatt hours generated thus:

$$V_{period} (\text{m}^3) = \text{kWh}_{period} (\text{kWh}) \times HAF_{site} (\text{m}^3/\text{kWh})$$

If, for example your total export of electricity for the period was 68400 kWh, then you would have abstracted a total volume of water of:

$$V_{period} (\text{m}^3) = 68400 \text{ kWh} \times 3.764 \text{ m}^3/\text{kWh} = 257457.6 \text{ m}^3$$

**Would you like to find out more about us,
or about your environment?**

**Then call us on
0300 065 3000 (Mon-Fri 9-5)**

**email
enquiries@naturalresourceswales.gov.uk**

**or visit our website
www.naturalresourceswales.gov.uk**

**incident hotline 0300 065 3000 (24hrs)
floodline 0345 988 1188**



Environment first: This publication is printed on paper made from 100 per cent previously used waste. By-products from making the pulp and paper are used for composting and fertiliser, for making cement and for generating energy.